

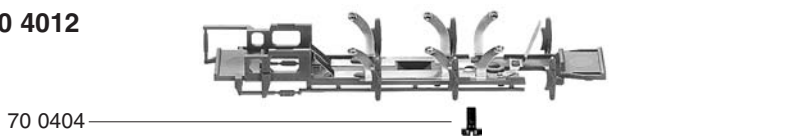

10 4011

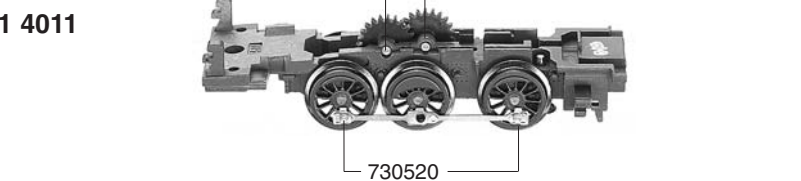

- 10 4011 Lokgehäuse kpl.
- 13 4011 Flutlichtleiter und Reichsbahnlaternen(Satz)
- 14 4010 Luftkessel
- 19 1011 Kleinteile(Satz)
- 19 4614 Pfeife
- 19 4803 Bremsschlauch
- 19 4811 Laterne vorn
- 19 4822 Laterne hinten
- 19 4824 Kupplungshaken
- 38 4015 Kuku-Deichsel
- 40 4012 Fahrgestell kpl. o. Motor
- 41 4011 Fahrgestell m. Rädern u. Kuppelstangen
- 42 4010 Steuerung kpl. m. Kuppelstangen u. Kreuzköpfen (Satz)
- 43 4010 Zylinderkasten li. u. re. (Satz)
- 50 4010 Motor kpl.
- 50 4910 Befestigungsbügel für Decoder
- 50 7801 Kohlehalter
- 50 7903 Motorhaltebügel
- 56 7606 Schnecke
- 60 4012 Stromabnehmereinsatz
- 63 4012 Motorhalteplatte
- 64 4202 Kondensator
- 64 4404 Kontaktpilzgarnitur
- 65 4073 Buchsenleiste f. Schnittstelle
- 66 4002 Schnittstellen-Blindstecker, 6-polig
- 70 0404 Schraube f. Deckplatte und Steuerung
- 71 2513 Schraube f. Gehäuse
- 73 0519 Zylinderstift f. Zahnräder
- 73 0520 Bolzen f. Kuppelstange
- 75 4040 Steckpuffer gewölbt
- 75 4041 Steckpuffer flach
- 6515 PROFI-Steckkupplung
- 6518 Kohlen und Federn
- 6535 Glühlampe

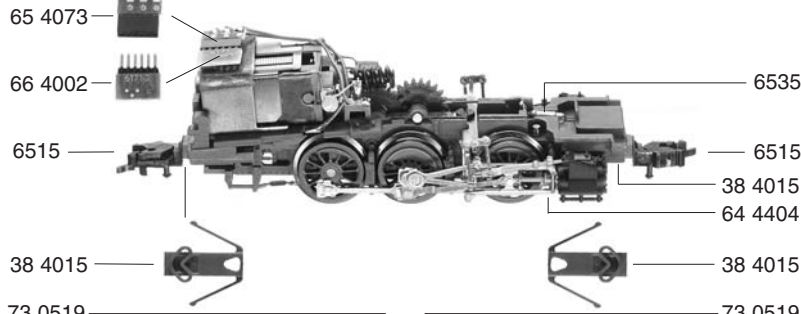
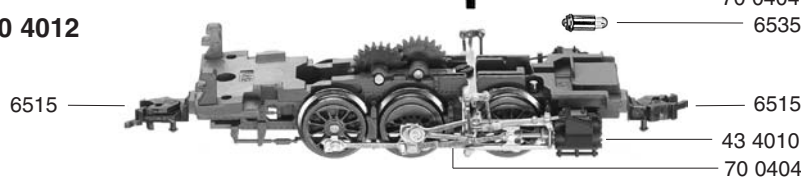
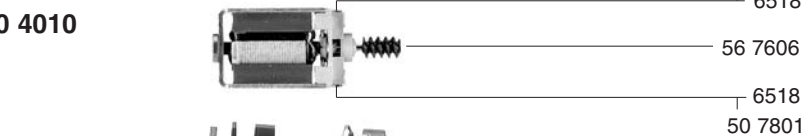
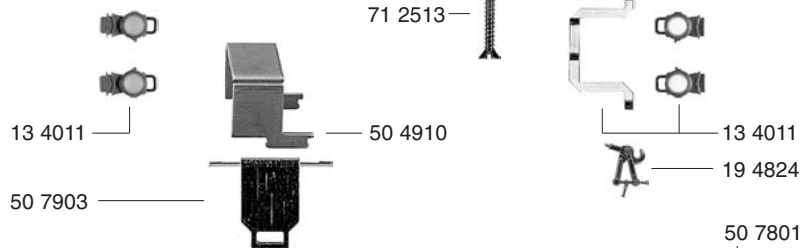
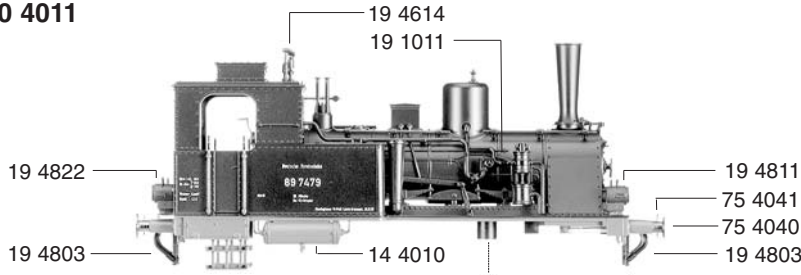



- 19 1011 Kleinteile (Satz)
- 51 4210 Treibrad, gr. Gegengewicht
- 51 4211 Treibrad, gr. Gegengewicht isoliert
- 51 4212 Kuppelrad, kl. Gegengewicht
- 51 4213 Kuppelrad, kl. Gegengewicht isoliert
- 52 4006 Achse
- 52 4007 Achse f. mittleren Radsatz

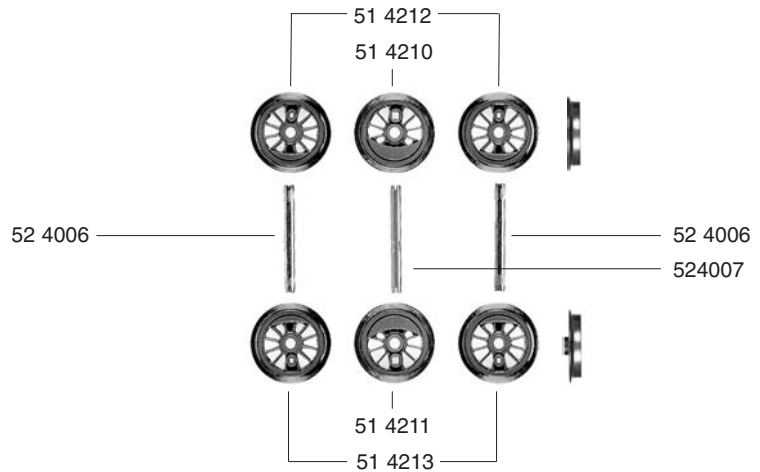

		Außen-Ø	Zähnezahl
56 4121	Zahnrad	7,5	13
56 4126	Zahnrad	12	22
56 4127	Zahnrad	5,5	9
56 4128	Zahnrad m. Ratschring	12	22
56 7606	Schnecke		

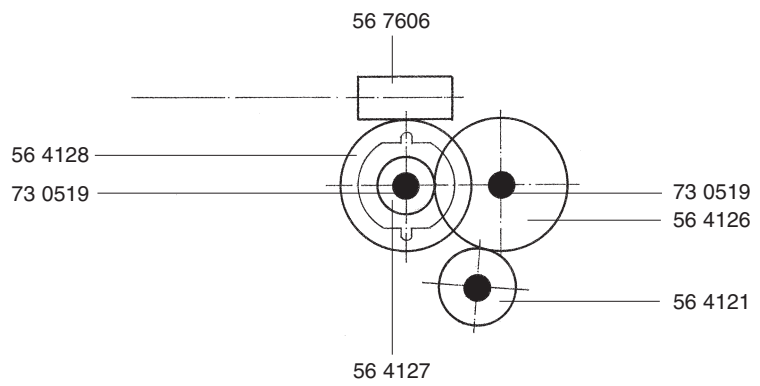

- 64 4102 Entstör-Drossel
- 64 4202 Entstör-Kondensator
- 64 4404 Kontaktpilzgarnitur

73 0519 Zylinderstift f. Zahnrad

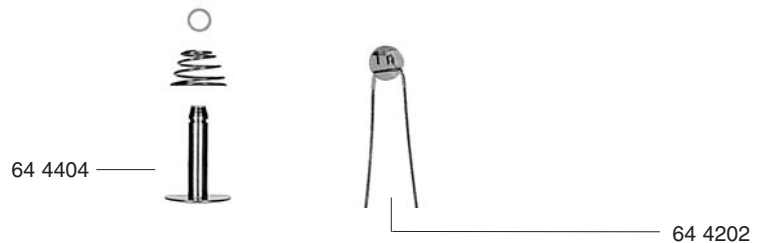
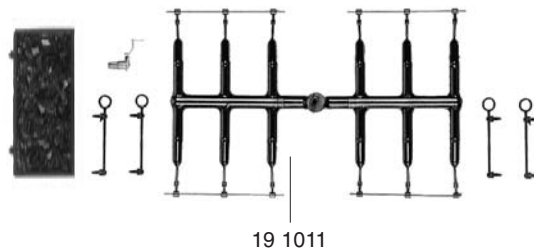

geeignete Decoder:

- DCC: 6876
- TWIN: 6846

