

FLEISCHMANN 4029

10 4029

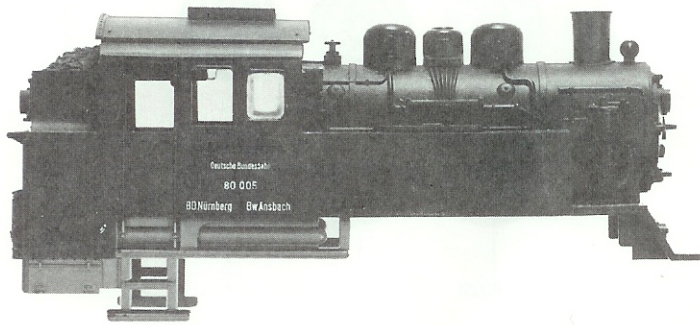

10 4029 Lokgehäuse kpl.

- 40 4029 Fahrgestell mit Motor und Beschwerung
- 42 4029 Steuerung mit Verbundstange kpl. - Satz
- 43 4029 Zylinderkasten

56 4740 Unterlagscheibe

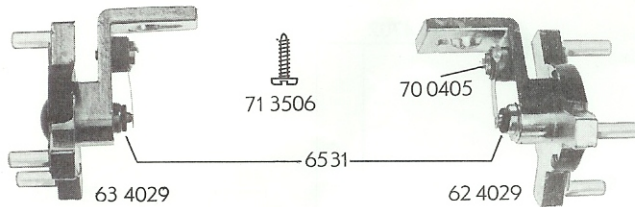

- 61 4003 Stromabnehmer
- 61 4906 Kontaktfeder
- 62 4029 Beleuchtungseinrichtung vorne
- 63 4029 Beleuchtungseinrichtung hinten

40 4029

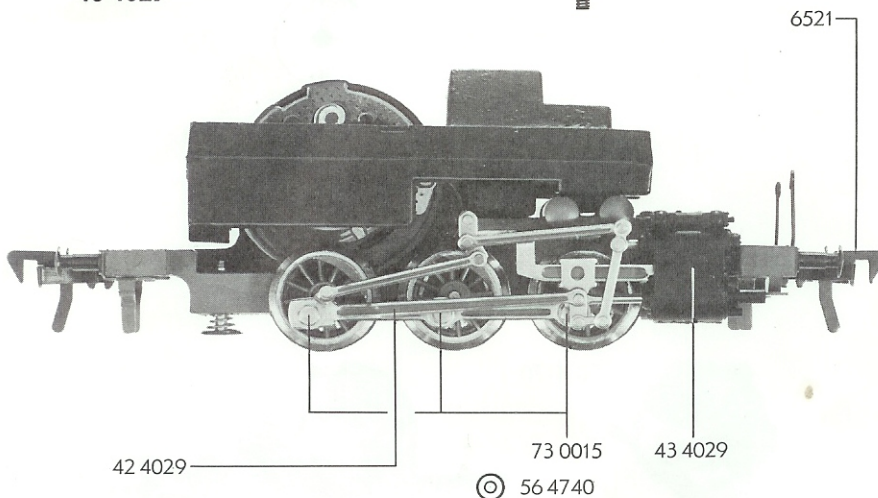

- 70 0404 Schraube
- 70 0405 Schraube
- 70 0615 Schraube
- 71 3506 Schraube
- 73 0006 Schraube
- 73 0015 Schraube
- 73 0021 Schraube
- 75 4001 Puffer
- 75 4029 Pufferbohle
- 75 4080 Pufferbohle

76 4012 Richtfeder f. Ugel

- 6521 Kupplung
- 6531 Glühlampe

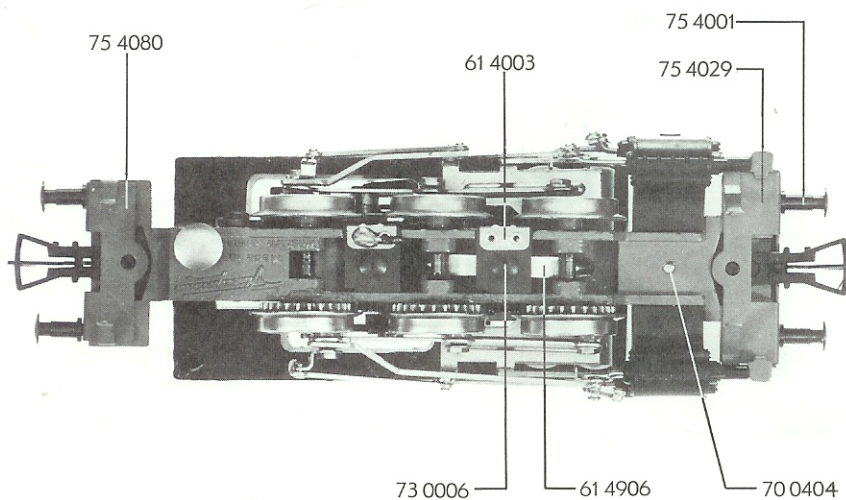

FLEISCHMANN 4029

4029 FLEISCHMANN

- 50 4029 Motor mit Motorblock
(ab Fertigung 1972)
- 50 4170 Motor
(bis Fertigung 1971)
- 51 4018 Lokrad
- 51 4020 Lokrad
- 51 4021 Lokrad
- 51 4023 Lokrad
- 52 4001 Achse

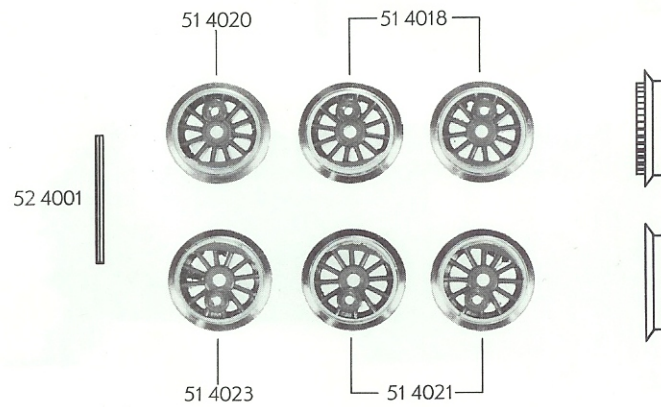

		Außen- ϕ	Zähnezahl	Zähnezahl
56 4102	Zahnrad	15	28	13
56 4103	Zahnrad	7	12	
56 4105	Zahnrad	10	18	
56 4107	Zahnrad	17	32	13
56 4603	Ritzel	7	12	
56 4702	Sicherungsring			

- 64 4101 Drossel
- 64 4201 Kondensator
- 64 4404 Kontaktpilzgarnitur

- 70 0313 Schraube
- 70 0412 Schraube

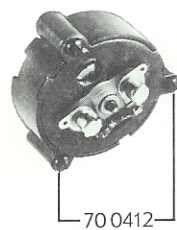
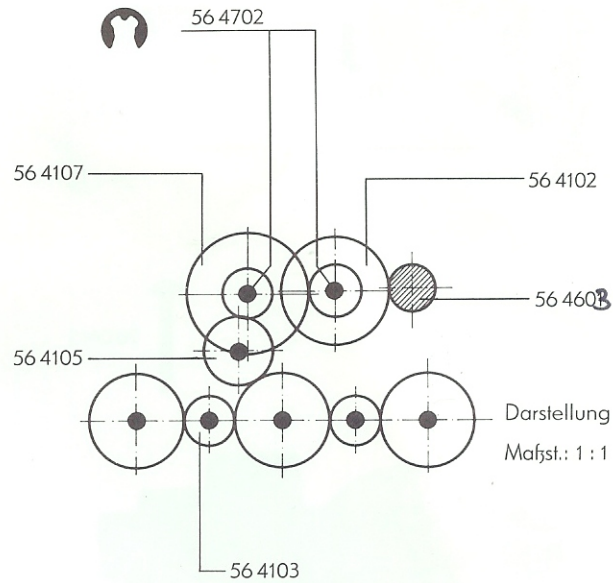

50 4170

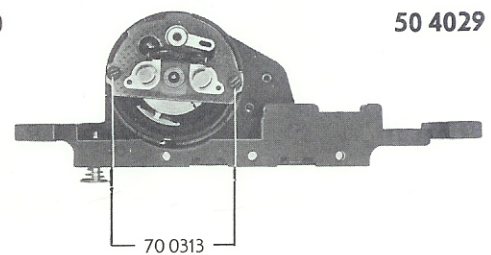

50 4029

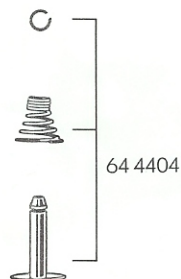

64 4404



64 4101



64 4201

4029 FLEISCHMANN