

- 10 4110 Lokgehäuse
- 13 4000 Lampenglas
- 16 4000 Beschwerung

- 34 4110 Kuppellasche

- 40 4110 Fahrgestell kompl. ohne Motor

- 42 ~~4110~~⁴⁰⁰⁰ Steuerung kompl. einschl. Verbundstange
- 43 ~~4000~~⁴¹¹⁰ Zylinderkasten

- 50 4001 Motor
- 53 4001 Radsatz ohne Zahnrad
- 53 4015 Radsatz mit Zahnrad
- 54 4001 Haftring
- 56 7604 Schnecke

- 61 4908 Stromabnahmefeder
- 64 4101 Drossel
- 64 4202 Kondensator
- 64 4402 Kontaktpilzgarnitur
- 65 4003 Schaltplatte

- 70 0403 Schraube
- 71 3513 Schraube
- 73 0501 Splint mit 6-kt.
- 73 0502 Splint ohne 6-kt.
- 75 4006 Puffer

- 6521 Kupplung

40 4110

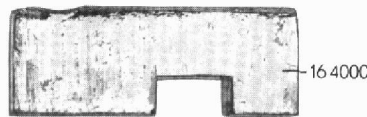
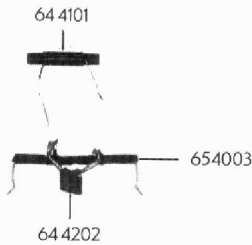
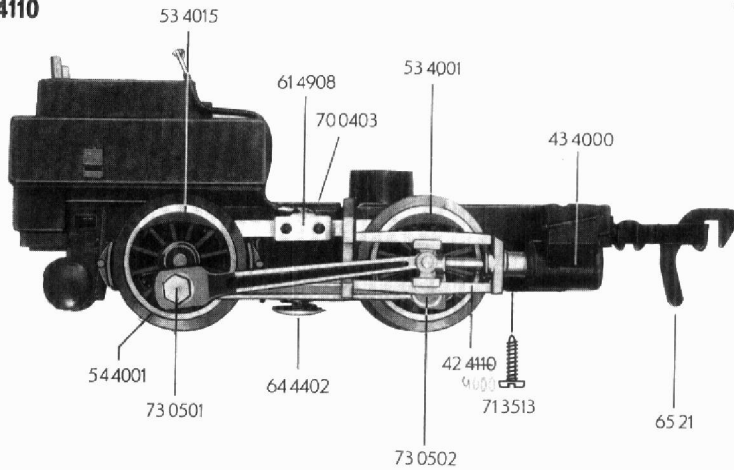

50 4001

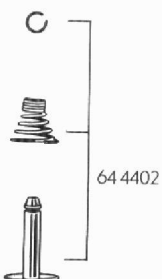
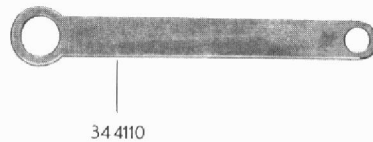
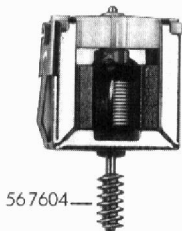

4110 FLEISCHMANN

20 4110 Tendergehäuse



20 4110

41 4110 Tenderbodenrahmen

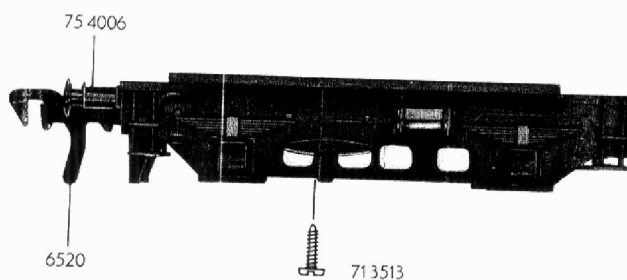

41 4110

53 4014 Tenderradsatz

- 71 3513 Schraube
- 73 0503 Splint (ohne Bild)
- 75 4006 Puffer

6520 Kupplung

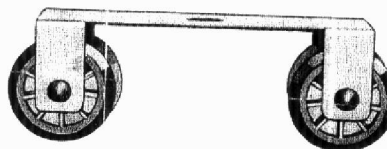

53 4014

Tender

4110 FLEISCHMANN