

# FLEISCHMANN 7142

## 10 7142

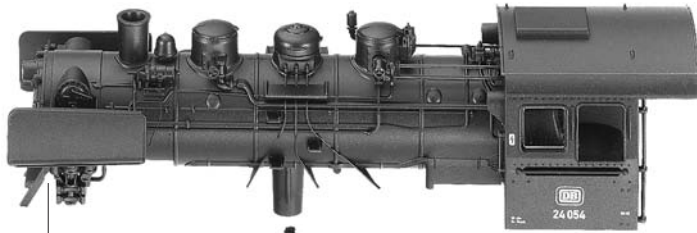

13 7142

71 3309

## 11 7142



## 30 7142

6535

70 4905

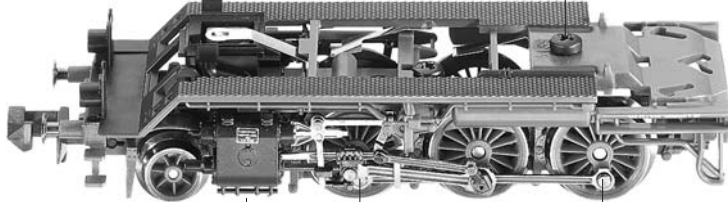

37 7142

48 7142

73 0562

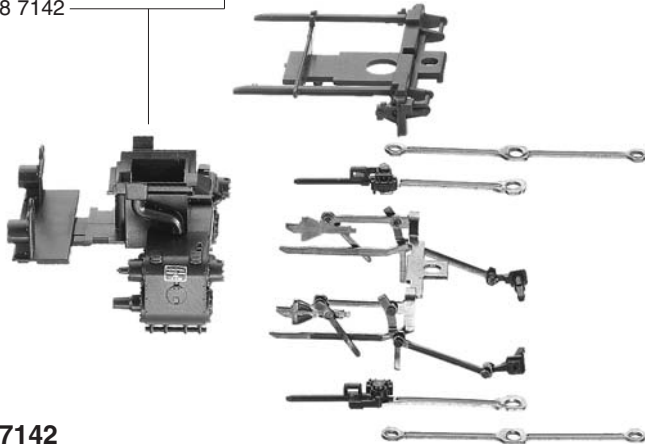

## 32 7142

## 31 7142

51 7081

75 7011

51 7080

51 7081

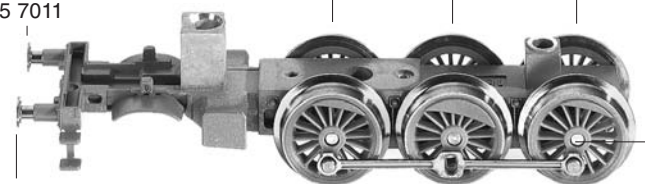

52 7007

75 7012

51 7081

51 7079

51 7081

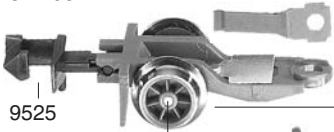

76 7007

## 37 7142

9525

52 7003

53 7077

33 7142



70 4903

- 10 7142 Lokgehäuse kpl.
- 11 7142 Umlaufblech kpl.
- 13 7142 Lichtleiter (Satz)

- 30 7142 Lokfahrgestell kpl.
- 31 7142 Lokfahrgestell m. Rädern u. Kuppelstangen
- 32 7142 Steuerung kpl.
- 33 7142 Deckplatte unten
- 37 7142 Vorlaufgestell kpl.

- 48 7142 Zylinderkasten

- 51 7079 Treibrad links
- 51 7080 Treibrad rechts
- 51 7081 Kuppelrad
- 52 7003 Achse f. 537077
- 52 7007 Achse f. Treib- u. Kuppelräder
- 53 7077 Vorlaufnachsatz

- 70 4903 Schraube f. 337142
- 70 4905 Schraube f. 117142
- 71 3309 Schraube f. 107142
- 73 0562 Bolzen f. Kuppelstangen
- 75 7011 Steckpuffer, gewölbt
- 75 7012 Steckpuffer, flach

- 6535 Glühlampe
- 9525 Standard-Steckkupplung
- 9545 PROFI-Steckkupplung (o. Abb.)

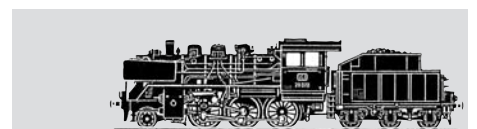

# 7142 FLEISCHMANN

- 20 7142 Tendergehäuse kpl.
- 21 7142 Tenderbodenrahmen kpl.
- 22 7142 Leitern (Satz)
  
- 34 7142 Lok-Tender Kuku-Deichsel
- 38 7009 Kupplungs-Adapter
  
- 40 7142 Tenderfahrgestell kpl. o. Motor
- 41 7142 Tenderfahrgestell m. Zahnrädern
  
- 50 7142 Motor kpl. m. Massefeder
- 50 7907 Motorhaltebügel
- 51 7003 Tenderrad m. N. o. Z.
- 51 7013 Tenderrad o. N. o. Z.
- 52 7007 Achse
- 54 7001 Haftreifen

		Außen-Ø	Zähnezahl	Zähnezahl
56 7136	Untersetzungsrad	6	18	12
56 7138	Zahnrad	4,5	13	
56 7153	Zahnrad auf Radsatz	5,4	16	

- 66 7000 Schaltlitze schwarz

- 70 0205 Schraube f. 207142
- 73 0542 Achse f. 567136
- 73 0564 Bundbolzen f. 567138
- 75 7011 Steckpuffer, gewölbt
- 75 7012 Steckpuffer, flach
- 76 7101 Zugfeder f. 347142

- 9525 Standard-Steck-Kupplung
- 9545 PROFI-Steck-Kupplung (o. Abb.)

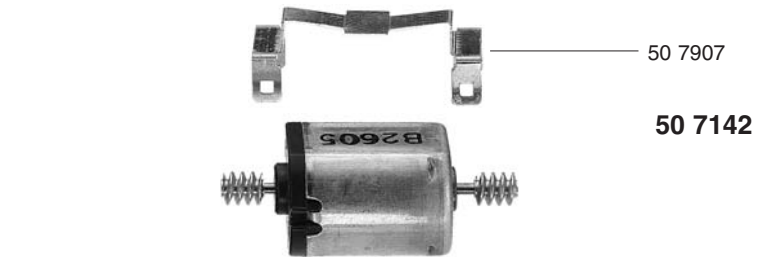

**Motor ist wartungsfrei!**

