

34 ohne Abb./no ill.
SOUND-DECODER
Sound-decoder

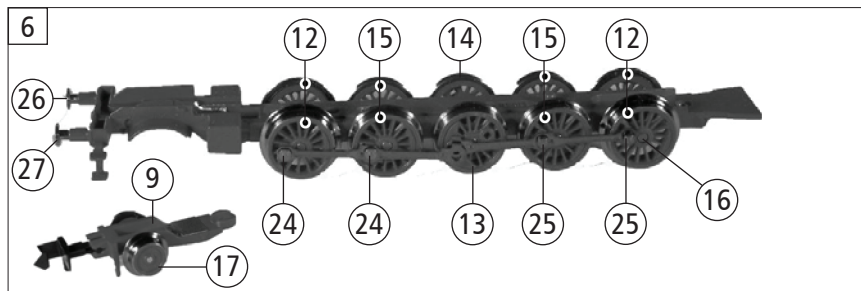
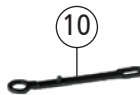
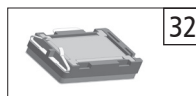
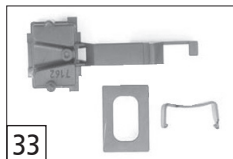

35 ohne Abb./no ill.
BUNDBOLZEN
Flanged bolt

715209 ÖBB Rh 52 = N

715279 = 🔊

Pos. Nr. Pos.no.	Beschreibung Description	Art.-Nr. Art.no.	Preisgruppe Price bracket
1	LOKGEHÄUSE KPL. Betr. Nr. 52.1591 Loco chassis complete no. 52.1591	10715209	029
2	UMLAUFBLECH Running board	11715209	025
3	LICHTLEITER Light conductor	13715201	006
4	PFEIFE Whistle	00197605	004
5	LOKFAHRGESTELL KPL. Loco chassis complete	30715209	040
6	LOKFAHRGESTELL MIT RÄDERN Loco chassis with wheels	31715209	032
7	STEUERUNG KPL. MIT KUPPELSTANGEN Reversing gear complete with coupling rod	32715201	017
8	ABDECKPLATTE UNTEN Cover plate bottom	00337186	006
9	VORLAUFGESTELL KPL. Carrying wheel	37715209	016
10	KUPPELLASCHE LOK-TENDER Coupling latch loco tender	38802100	004
11	ZYLINDERKASTEN KPL. BR 52 Cylinder box complete BR 52	48715201	013
12	KUPPELRAD Coupled wheel	51717100	008
13	TREIBRAD LINKS Driving wheel left	51716900	009
14	TREIBRAD RECHTS Driving wheel right	51717000	009
15	KUPPELRAD Cupled wheel	51717200	008
16	ACHSE Axle	00527007	001
17	VORLAUFRADESATZ, SCHEIBENRADESATZ KPL. Carrying wheelset cpl., disc wheelset cpl.	53715100	014
18	LEITERPLATTE KPL. PCB complete	65714100	022
19	LEITERPLATTE KPL. PCB complete	65714200	022
20	STECKER FÜR SCHNITTSTELLE 6-POL Jumper 6-pin	00664005	013
21	LINSENSCHRAUBE M1,6x2-4,8 H Button screw M1,6x2-4,8 H	00704902	002
22	LINSENSCHRAUBE M1,6x4 MIT KREUZ- SCHLITZ Button screw M1,6x4 with cross-slot	00704904	002
23	BLECHSCHRAUBE MIT KREUZSCHLITZ Tapping screw	00713309	001
24	BOLZEN FÜR KUPPELSTANGE Bolt for coupling rod	00730562	002
25	BOLZEN FÜR KUPPELSTANGE Bolt for coupling rod	00730570	001
26	STECKPUFFER (GEWÖLBT) Plug-in buffer (curved)	75706600	001
27	STECKPUFFER (FLACH) Plug-in buffer (flat)	75706700	003
28	ZUGFEDER SCHWARZ Draw spring black	76710800	001
29	FEDERBÜGEL FÜR ZUGFEDER Spring clip for draw spring	76711000	001
Sound			
30	LOKGEHÄUSE KPL. Loco chassis complete	10715279	029
31	LOKFAHRGESTELL KPL. Loco chassis complete	30715279	040
32	LAUTSPRECHER 8x12 Loudspeaker 8x12	68701700	016
33	LAUTSPRECHERAUFNAHME, BÜGEL,... Part set for loudspeaker	68701400	016
34	SOUND-DECODER ohne Abb. Sound-decoder no ill.	68715279	041
35	BUNDBOLZEN ohne Abb. Flanged bolt no ill.	73059800	003

Änderungen in Konstruktion und Ausführung vorbehalten
We reserve the right to change the construction and specification

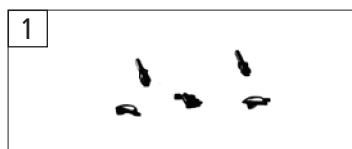
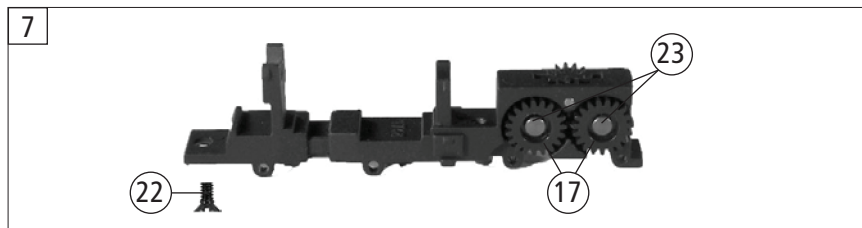
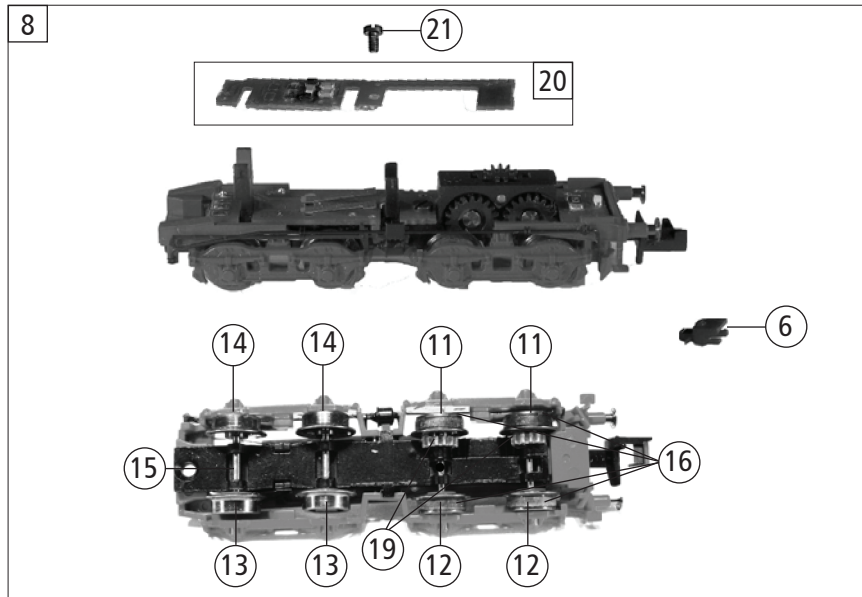
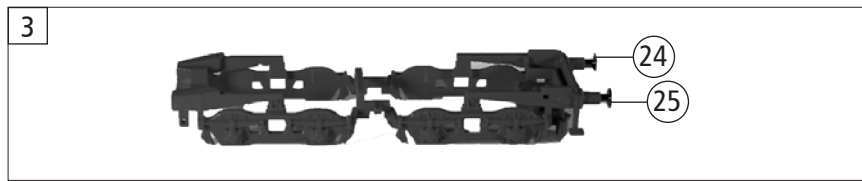
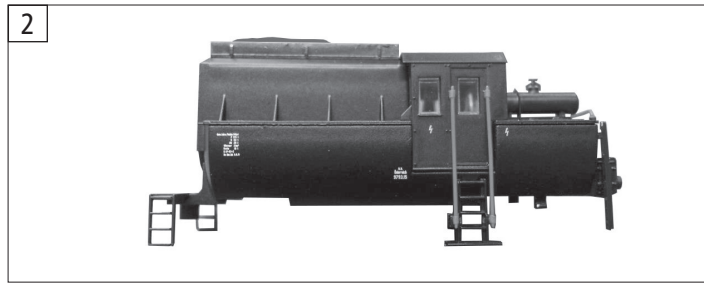

715209		ÖBB	Rh 52	=	N	
715279				=	🔊	
Pos. Nr. Pos. no.	Beschreibung Description	Art.-Nr. Art. no.	Preisgruppe Price bracket			
1	ZUGHAKEN-BREMSKUP.-KOLBENSTANGE Coupling hook, brake coupling, piston rod	19715201	012			
2	TENDERGEHÄUSE KPL. Betr. Nr. 52.1591 Tender body complete no. 52.1591	20715209	027			
3	TENDERRAHMEN KPL. Tender framework complete	21715209	023			
4	LEITER-TREPPE-HANDLAUF-ROHRLEITUNG Ladder-treadle-handrail-pipe	22715209	011			
5	LICHTLEITER FÜR TENDER Light conductor for tender	23715201	006			
6	ADAPTER Adaptor	38702400	007			
7	TENDERFAHRGESTELL MIT ZAHNRÄDER Tender chassis with gears	41715201	027			
8	TENDERFAHRGESTELL KPL. OHNE MOTOR Tender chassis complete w/o motor	40715209	033			
9	MOTOR Motor	50715201	030			
10	MOTORHALTEBÜGEL Motor retainer clip	50791400	002			
11	TENDERRAD M.N. SCHWARZ VERN. Tender wheel with traction tyre	51716600	007			
12	TENDERRAD M.N. SCHWARZ VERN. Tender wheel with traction tyre, insulated	51716700	007			
13	TENDERRAD O.N. SCHWARZ VERN. Tender wheel w/o traction tyre, insulated	51716400	007			
14	TENDERRAD O.N. SCHWARZ VERN. Tender wheel w/o traction tyre	51716500	007			
15	ACHSE Axle	52701200	001			
16	HAFTREIFEN Traction tyre	00547001	001			
17	ZAHNRAD Gear wheel	56718100	003			
18	SCHNECKE (MESSING) Worm gear	56762200	009			
19	RITZEL Gear wheel	56762000	001			
20	LEITERPLATTE KPL. (TENDER) PCB complete (tender)	65714000	018			
21	SCHRAUBE M 1,4 X 3 Screw	00700203	001			
22	SCHRAUBE Screw	00702304	001			
23	BUNDBOLZEN Flanged bolt	00730578	003			
24	STECKPUFFER (GEWÖLBT) Plug-in buffer (curved)	75706600	003			
25	STECKPUFFER (FLACH) Plug-in buffer (flat)	75706700	003			
	STANDARD-KUPPLUNG (ohne Abb.) Standard coupling (no ill.)	9521	---			
	STANDARD-STECKKUPPLUNG (ohne Abb.) Standard clip in coupling (no ill.)	9525	---			
	PROFI-STECKKUPPLUNG (ohne Abb.) Profi clip in coupling (no ill.)	9545	---			
	PROFI-KUPPLUNG (ohne Abb.) Profi coupling (no ill.)	9541	---			

Ersatzteile erhalten Sie direkt unter www.fleischmann.de, bei Ihrem Fachhändler, oder Ihrer Landesvertretung.
Spare parts can be ordered directly at www.fleischmann.de and from your local dealer or country representative.