

715581 BR 55 2875 DB		DCC	=	N
Pos. Nr. Pos.no.	Beschreibung Description	Art.-Nr. Art.no.	Preisgruppe Price bracket	
1	LOKGEHAEUSE BR 55 DB EP III loco body assembly	10715581	031	
2	LICHTLEITER Light conductor	00137155	006	
3	PFEIFE whistle	00197605	004	
4	LAMPE ELEKTR.VORNE F.7152,-55 lamp front	00197812	005	
5	LAMPE ELEKTR.HINT.F.7152,-55 lamp rear	00197813	005	
6	TENDERGEHÄUSE KPL. Tender body complete	20715581	024	
7	TENDERBODENRAHMEN KPL. Tender framework bottom complete	21715581	023	
8	LOKFAHRGEST.KPL BR55 DB EP.III loco chassis complete	30715581	040	
9	LOKFAHRGEST.M.RAEDERN,KUPPELST loco chassis with wheels, coupling rod	31715581	032	
10	KREUZKÖPFE U. VERBUNDSTANGEN cross-head and coupling rod	32715581	017	
11	DECKPLATTE UNTEN cover plate bottom	00337155	007	
12	KU-KU DEICHSEL Short coupling reception	00347155	005	
13	ADAPTER F.DAMPFLOKS adaptor for loco steam	00387003	007	
14	TENDERFAHRGESTELL O.MOT. BR55 tender chassis w/o motor	40715581	033	
15	TENDERFAHRGESTELL M.Z. Tender chassis complete with gear wheel	00417155	024	
16	MOTOR motor	50715581	028	
17	KOHLEHALTER Brush holder	00507802	003	
18	MOTORHALTEBUEGEL Motor retainer clip	00507901	002	
19	TENDERRAD O.Z.M.N.ISO.ROT Tender wheel w/o gear w. with trac. tyre, insul.	00517003	006	
20	TENDERRAD O.Z.O.N.ISO.ROT Tender wheel w/o gear w. w/o trac. tyre, insul.	00517013	007	
21	KUPPELRAD O.Z.O.N.ISO.ROT Coupled wheel w/o tract. tyre w/o gear w. inslu.	00517044	006	
22	KUPPELRAD NIEDR.SPURKRANZ BR55 coupled wheel	00517063	007	
23	TREIBRAD LINKS ROT driving wheel left side	00517064	007	
24	TREIBRAD RECHTS ROT driving wheel right side	00517065	007	
25	ACHSE axle	00527007	001	
26	HAFTREIFEN traction tyre	00547001	001	
27	ZAHNRAD Z:13 SCHW.VERN. Gear wheel nickel-plated	00567123	006	
28	ZAHNRAD Z:12/8 ROT gear wheel	00567141	002	
29	ZAHNRAD Z:12/8 BRAUN gear wheel	00567142	002	
30	SCHNECKE D = 4MM L = 5MM worm gear	00567601	007	
31	STROMABNEHMEREINSATZ KPL BR 55 power pick-up assembly complete	60715581	031	
32	HALTEPLATTE F.87086 cover plate	00627086	003	
33	ENTSTOERKONDENSATOR Anti-noise capacitor	00644202	006	
34	SCHRAUBE M 1,4 X 3 screw	00700203	001	

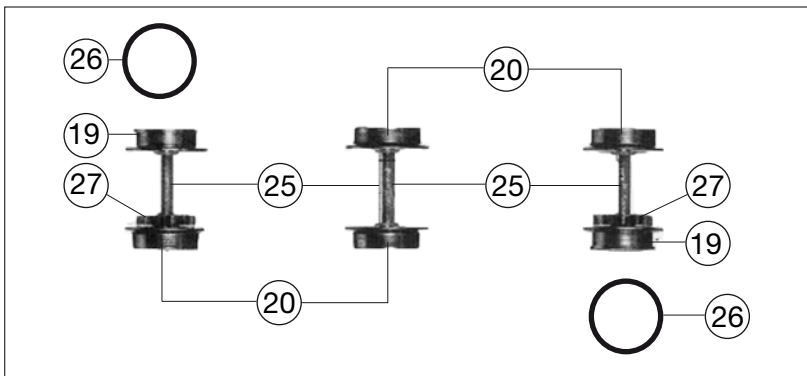

715581 BR 55 2875 DB		DCC	=	N
Pos. Nr. Pos.no.	Beschreibung Description	Art.-Nr. Art.no.	Preisgruppe Price bracket	
35	SCHRAUBE screw	00700306	001	
36	SCHRAUBE screw	00702903	001	
37	BOLZEN F.ZAHNRAD bolt for gear wheel	00730523	002	
38	BOLZEN F.KUPPELSTANGE bolt for coupling rod	00730546	002	
39	STECKPUFFER (GEWÖLBT) plug-in Buffer, curved	00757011	002	
40	STECKPUFFER (FLACH) Plug-in buffer, flat	00757012	002	
41	BLATTRICHTFEDER F.KUPPLUNG N Flat straightening spring for coupling	00767006	001	
42	DRUCKFEDER F.LOK-TENDER-KUKU pressure spring for loco tender	00767012	001	
43	ERSATZ-SCHLEIFKOHLEN carbon brushes set	6518	---	
44	ERS.-GLUEHLAMPE KLAR M.STECKFA Replacement bulb, clear, with plug-in socket	00006535	008	
45	STANDARD-KUPPLUNG standard coupling	9521	---	
46	STANDARD-STECKKUPPLUNG standard plug-in coupling	9525	---	
--	PROFI-KUPPLUNG profi coupling	9541	---	
--	PROFI-STECKKUPPLUNG profi-plug-in coupling	9545	---	

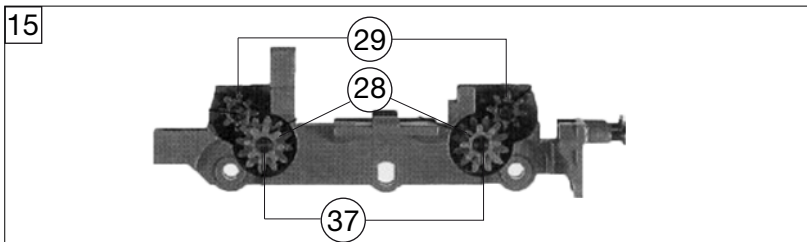
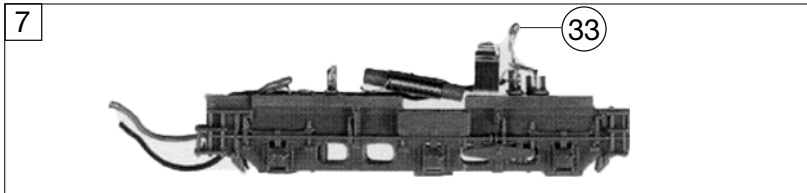
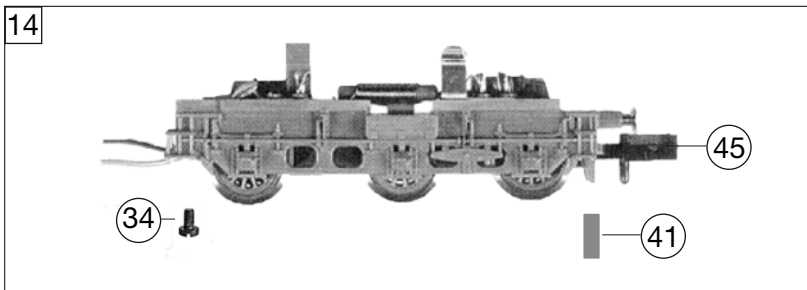
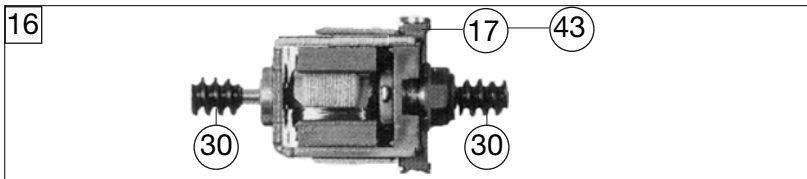
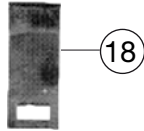
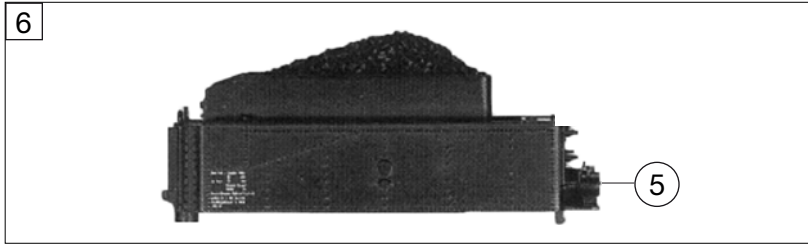