

107333

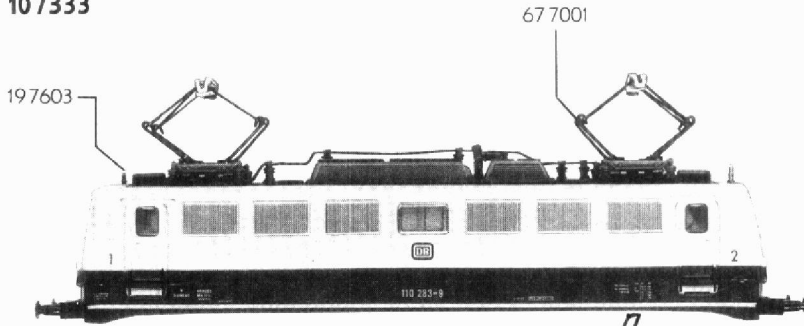

700303

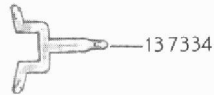
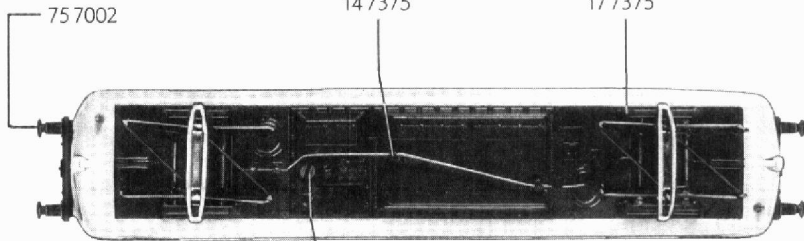

647375

407333

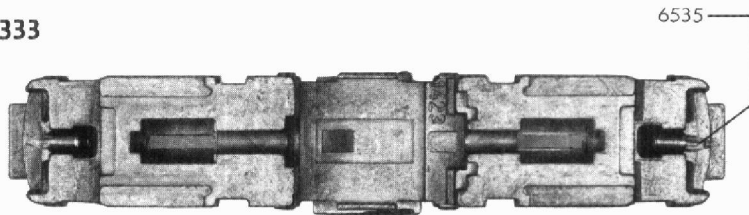

657007

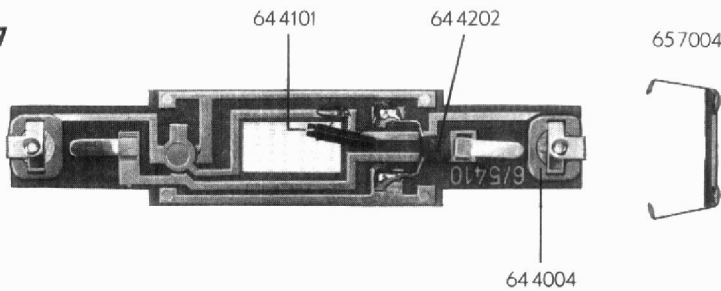

457334

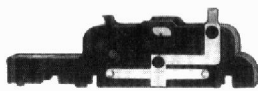

527002



567101

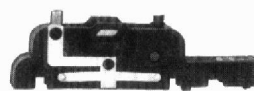

467334



9521

417334



702303

- 10 7333 Lokgehäuse kompl.
- 13 7334 Flutlichtleiter
- 14 7375 Isolatorensatz
- 17 7375 Traverse für Scherenstromabnehmer
- 19 7603 Pfeife
- 40 7333 Lokfahrgestell o. Motor
- 41 7334 Drehgestellrahmen
- 45 7334 Drehgestellblock kompl. vorne m. Stromabnehmer
- 46 7334 Drehgestellblock kompl. hinten m. Stromabnehmer
- 52 7002 Achse
- 56 7101 Zahnrad
- 64 4000 Diode (Lichtwechsel)
- 64 4004 Ventilzelle kompl.
- 64 4101 Drossel
- 64 4202 Kondensator
- 64 7375 Umschalter für Oberleitung mit Schaltfeder
- 65 7004 Kontaktbügel
- 65 7007 Schaltplatte kompl.
- 67 7001 Scherenstromabnehmer
- 70 2303 Schraube
- 75 7002 Puffer
- 6535 Glühlampe
- 9521 Kupplung

700303 SCHRAUBE FÜR 677001 11.2.85

767006 Rielfeder

7333 FLEISCHMANN

- 50 7334 Motor
- 53 7018 Radsatz kompl.
- 53 7019 Radsatz kompl.
- 54 7002 Haftreifen
- 56 7604 Schnecke

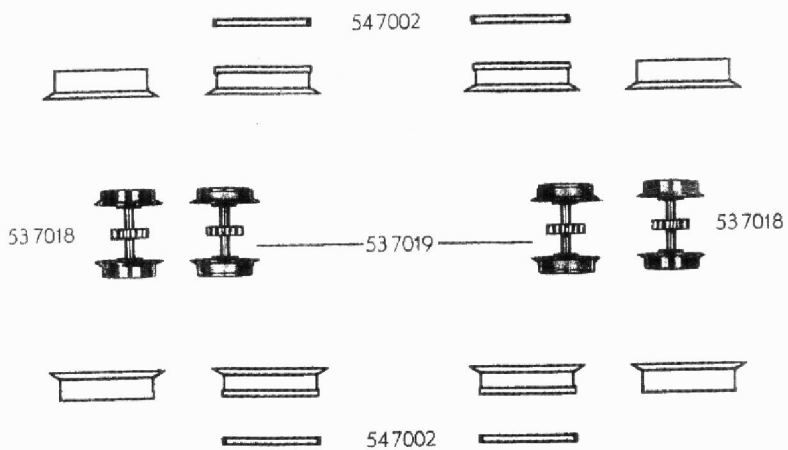

507334

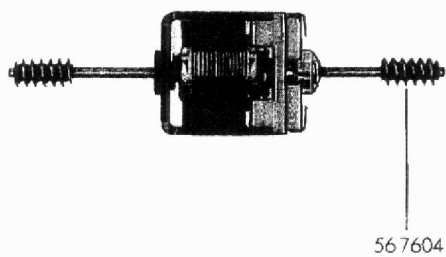

7333 FLEISCHMANN