

Pos. Nr. Pos.no.	Beschreibung Description	Art.-Nr. Art.n.o.	Preisgruppe Price bracket
1	GEHAEUSE KPL.F.MOT.WAGEN VT95 body assembly complete	107400712	028
2	INNENEINRICHTUNG M.KONTAKTIER. Interior fittings with contact	117400712	---
3	INNENBELEUCHTUNG-SATZ Interior lighting	137400712	---
4	FENSTER-SATZ set of windows	147400712	---
5	AUFSTECKLAMPE/Satz attachment lamp set	00197817	007
6	BODEN F.TRIEBWAGEN 740201 Motor coach floor plate	307400712	---
7	FRONTWAND MIT SCHÜRZE -SATZ Front wall with skirt -set	00337400	011
8	KUPPELSTANGE coupling rod	00387401	002
9	KUKU-DEICHSEL Short coupling reception	00388014	002
10	ACHSHALTER /SATZ axle holder set	00437400	009
11	MOTOR M.SCHW.M.MASSEKONTAKT Motor with flywheel w/ ground contactor	05074002	029
12	KOHLEHALTER brush holder	00507802	003
13	MOTORHALTEBUEGEL motor retainer clip	00507904	002
14	MOTORHALTER-SATZ F.7400 motor retainer set	00507905	011
15	ACHSE axle	00527009	001
16	RADSATZ M.Z.O.N.F.7400 Wheelset complete with gear wheel, w/o trac.	00537059	012
17	UNTERSETZUNGSRAD Z:14/9 SCHW. Reduction gear wheel	00567145	006
18	SCHNECKE D = 3,5MM L = 5MM worm	00567611	006
19	GLÜHLAMPE 12 VOLT !KLAR M SOCK bulb clear with soket	00627400	011
20	ABSCHIRMBLECH cover plate	00637400	001
23	ENTSTOERKONDENSATOR Anti-noise capacitor	64420900	005
24	STAHLBUEGEL(PUFFER F.7400) Clamp type buffer	00757020	001
25	RICHTFEDER F.DEICHSEL L=14 MM Straightening spring for short coupling	00767010	001
26	ERSATZ-SCHLEIFKOHLEN carbon brushes set	6518	---
27	PROFI-STECKKUPPLUNG profi plug-in coupling	9545	---

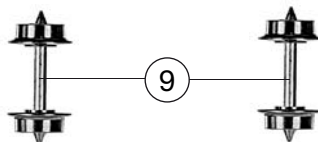
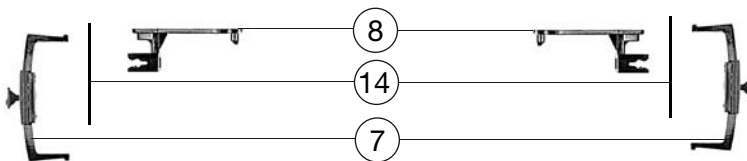
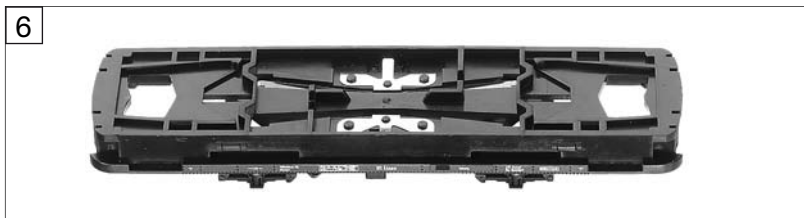
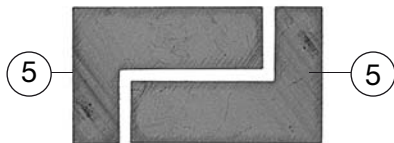
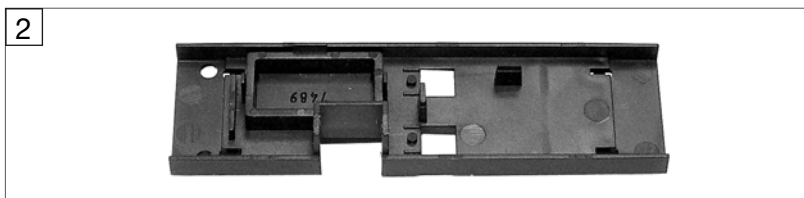
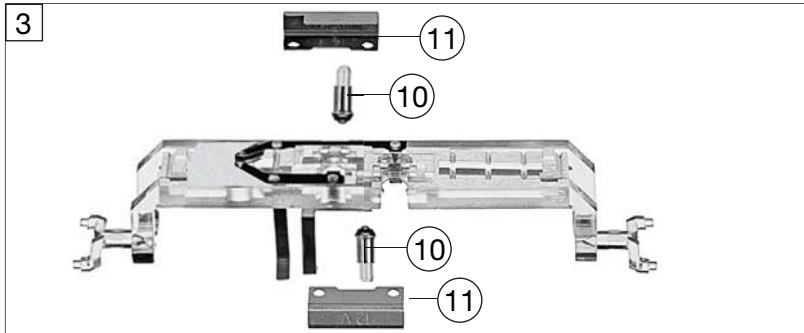
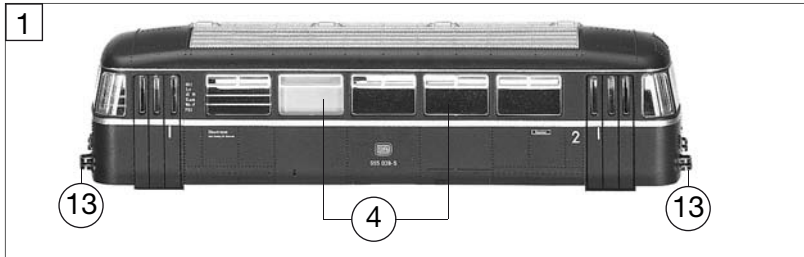

740071		VS 142 124	DB	=	🔊	N
Pos. Nr. Pos. no.	Beschreibung Description	Art.-Nr. Art. no.	Preisgruppe Price bracket			
1	GEHÄUSE KPL.FÜR BEIWAGEN Body assembly complete	107400713	027			
2	INNENEINRICHTUNG F.BEIWAGEN Interior fittings with contact	117400713	---			
3	INNENBELEUCHTUNG-SATZ Interior lighting	137400713	---			
4	FENSTER-SATZ F.7403 Set of windows	00147403	016			
5	BESCHWERUNG Ballast	00167401	007			
6	WAGENBODEN FÜR BEIWAGEN Car floor	307400713	---			
7	FRONTWAND MIT SCHÜRZE -SATZ Front wall with skirt -set	00337400	011			
8	KUKU-DEICHSEL Short coupling reception	00388014	002			
9	RADSATZ O.Z.O.N.F.7401/ICE-T W Wheelset complete with gear wheel	00537060	007			
10	GLÜHLAMPE 12 VOLT !KLAR M SOCKEL Bulb clear with socket	00627400	011			
11	ABSCHIRMBLECH Cover plate	00637400	001			
	LAUTSPRECHER 9x16 Fox mit Kleb (o. Abb.) Speaker 9x16 with adhesive (w/o illustr.)	68701100	016			
13	STAHLBUEGEL(PUFFER F.7400) Clamp type buffer	00757020	001			
14	RICHTFEDER F.DEICHSEL L=14 MM Straightening spring for short coupling	00767010	001			
15	PROFI-STECKKUPPLUNG Profi plug-in coupling	9545	---			
	SOUND-DECODER f.740071-3 (o. Abb.) Sound decoder (w/o illustr.)	687400713	41			