

Pos. Nr. Pos.no.	Beschreibung Description	Art.-Nr. Art.no.	Preisgruppe Price bracket
7560008	DB AG BR 146.2		N
7570008			N
1	LOKGEHÄUSE KPL.O.PANTO. Body assembly complete w/o panto.	107560008	35
2	FÜHRERSTAND/SATZ Driver's cab inset	12724504	19
3	LICHTMASKE Light mask	12738805	6
4	LICHTABDECKUNG Light cover	127560008	3
5	ZUGHAKEN-BREMSKUPPLUNG-SATZ Coupling hook,break coupling set	19733001	12
6	TS-ISOLATOREN Part set-Isolators	19738801	13
7	TS-SIGNALHÖRNER Part set-Horns	19765200	11
8	DACHLEITUNG Roof wiring	19797100	6
9	TS-GRIFFE Part set-Handrails	19795300	8
10	ANTENNE KURZ Antenna short	197570008	3
11	TRITT Treadle	197560008	6
12	SCHNEERÄUMER-SATZ Snow plow set	22724501	12
13	MOTOR KPL. Motor complete	50738901	29
14	MOTORHALTER Motor retainer clip	50792000	8
15	KOHLEBÜRSTENHALTER Carbon brushes holder	50780400	4
16	SCHNECKE Worm gear	56762500	6
17	TS-FENSTER+LICHTLEITER Part set-Windows+light conductors	137560008	19
18	EINHOLMSTROMABN.M.LANG.SCHLEIF Single arm panto. w/ long contact shoe	67703600	22
19	LEITERPLATTE UNTEN KPL. Lower PCB, complete	65721800	18
20	LEITERPLATTE KPL OBEN MIT LICHT Upper PCB complete with light	65723800	23
21	BRÜCKENSTECKER Jumper	66710800	18
22	FK-SCHRAUBE M1,2x2,6 mm FK-Screw	70900005	2
23	GF-SCHRAUBE M1,6x4 mm GF-Screw	114850	3
24	KONTAKTBÜGEL F. PLATINEN Contact plate for PCB	00657022	12
Sound			
25	LAUTSPRECHER Loudspeaker	68701100	16
26	LAUTSPRECHERAUFNAHME Loudspeaker reception	68702300	6
27	SOUNDDECODER Sound decoder	68158018	40

Änderungen in Konstruktion und Ausführung vorbehalten
We reserve the right to change the construction and specification

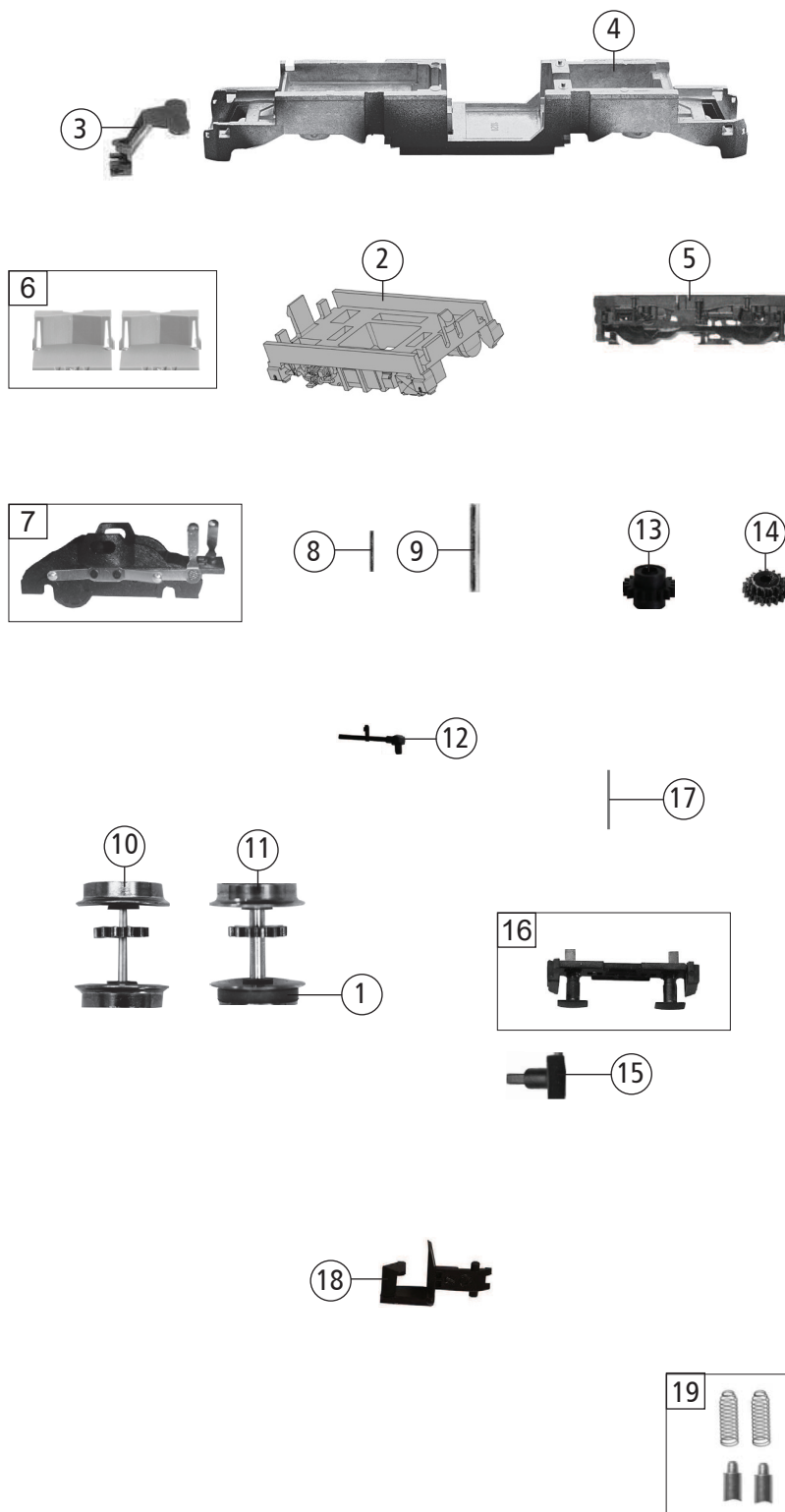

Pos. Nr. Pos.no.	Beschreibung Description	Art.-Nr. Art.no.	Preisgruppe Price bracket
7560008	DB AG BR 146.2		N
7570008			N
1	HAFTREIFEN Traction tyre	00547002	1
2	TRAFOWANNE Transformer tub	337560008	13
3	KUKU-DEICHSEL Short coupling reception	00387006	5
4	FAHRGESTELLRAHMEN Chassis frame	40724504	19
5	DREHGESTELLRAHMEN Bogie framework	41724501	11
6	DEICHSELABDECKUNG -SATZ Shaft cover plate set	43724501	9
7	DREHGESTELLBLOCK KPL. Bogie block complete	45724504	18
8	ACHSE Axle	00527009	1
9	ACHSE F. DREHGESTELLBESTIGUNG Bogie fixation pin	00527010	1
10	RADSATZ KPL. MIT ZAHNRAD Wheelset complete, w. gear wheel	53717600	15
11	RADSATZ KPL. MIT ZAHNRAD Wheelset complete, w. gear wheel	53717700	15
12	ZUGKRAFTANLENKUNG Bogie linkage	19739001	6
13	UNTERSETZUNGSRAD Reduction gear wheel	56719600	5
14	ZAHNRAD Gear wheel	56719500	5
15	PUFFER Buffer	75711900	4
16	PUFFERTRÄGER KPL. Buffer beam complete	75738801	11
17	RICHTFEDER F.DEICHSEL L=15mm Straightening spring f. drawbar	00767008	1
18	KUPPLUNG N-SPUR Coupling	98189	6
19	ERSATZ SCHLEIFKOHLEN Carbon brushes set	6518738902	9