

781308		BR 055 DB	=	N
Pos. Nr. Pos.no.	Beschreibung Description	Art.-Nr. Art.no.	Preisgruppe Price bracket	
1	LOKGEHÄUSE KPL. F.781308 BR 55 Body assembly complete for 781308	10781308	031	
2	FLUTLICHTLEITER Light conductor	00137155	006	
3	PFEIFE BRÜN. Loco whistle	00197605	004	
4	LAMPE EL. VORN Front lamp	00197812	005	
5	LAMPE EL. HINTEN Back lamp	00197813	005	
6	ANTENNE SCHW. VERN. Antenna black,nickel-plated	19784700	003	
7	TENDERGEHÄUSE KPL. F.781308 Tender body complete for 781308	20781308	024	
8	TENDERBODENRAHMEN KPL. Tender framework	00217155	023	
9	LOKFAHRGESTELL KPL F.715501 Loco chassis complete for 715501	30715501	040	
10	LOKFAHRGEST.M.RAEDERN,KUPPELST Loco chassis w.gear wheels and coupling rod	31715501	032	
11	KREUZKÖPFE U. VERBUNDSTANGEN Cross-heads and coupling rods	32715501	017	
12	DECKPLATTE UNTEN Lower cover plate	00337155	007	
13	KUKU-DEICHSEL Short coupling reception	00347155	005	
14	ADAPTER F.DAMPFLOKS Adaptor for steam loco	00387003	007	
15	TENDERFAHRGESTELL KPL. OHNE MO Tender chassis complete w/o motor	00407155	033	
16	TENDERFAHRGESTELL MIT ZAHNRÄDE Tender chassis with gear wheels	00417154	024	
17	MOTOR Motor	00507155	028	
18	KOHLENROHR Brush pipe	00507802	003	
19	MOTORHALTEBÜGEL SCHW. VERN. Motor retainer clip black,nickel-plated	00507901	002	
20	TENDERRAD O.Z.M.N.ISO.ROT Tender wheelset w/o gear wheel ,w.tract.tyre	00517003	006	
21	TENDERRAD O.Z.O.N.ISO.ROT Tender wheelset w/o gear wheel ,w/o tract.tyre	00517013	007	
22	LOKRAD N.H.UGR. Loco wheel small counterweight insul.	00517044	006	
23	KUPPELRAD Coupled wheel	00517063	007	
24	TREIBRAD LI. Driving wheel left	00517064	007	
25	TREIBRAD RE. Driving wheel right	00517065	007	
26	ACHSE Axle	00527007	001	
27	HAFTREIFEN Traction tyre	00547001	001	
28	ZAHNRAD Z:13 SCHW.VERNICKELT Gear wheel Z=13 black,nickel-plated	00567123	006	
29	ZAHNRAD Gear wheel	00567141	002	
30	ZAHNRAD Gear wheel	00567142	002	
31	SCHNECKE D = 4MM L = 5MM Worm gear D=4mm, L=5mm	00567601	007	
32	STROMABNEHMEREINST. KPL 715501 Power pick-up assembly for 715501	60715501	031	
33	ENTSTOERDROSSEL Suppressor choke	00644101	007	
34	KONDENSATOR Capacitor	64420900	005	

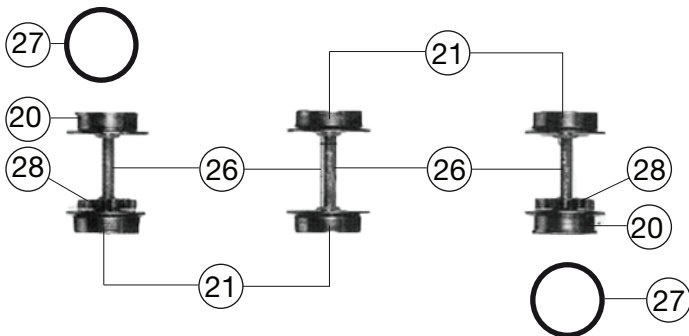
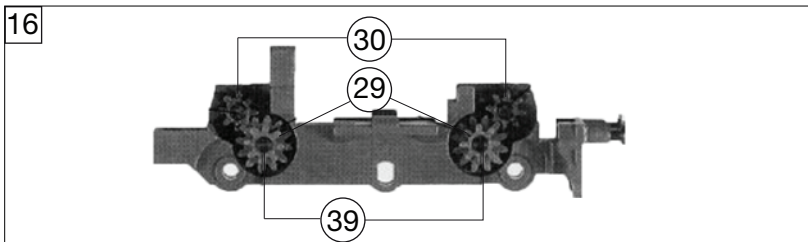
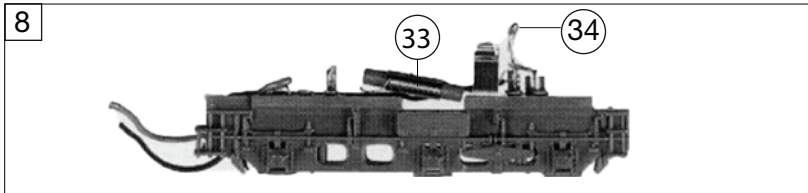
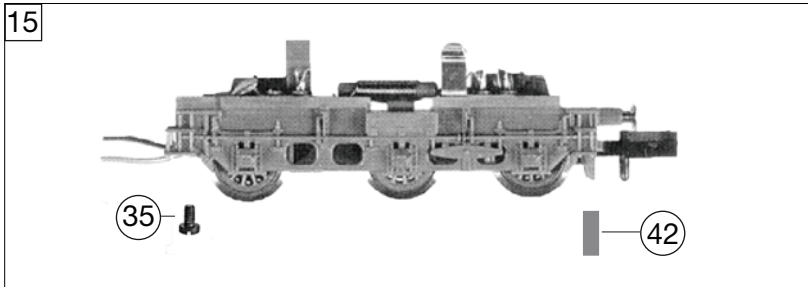
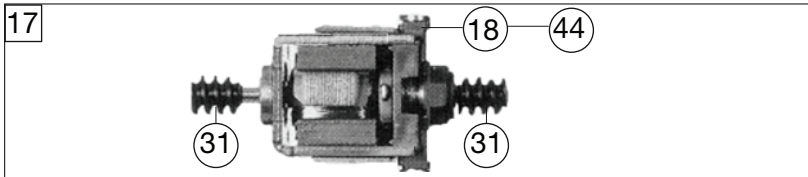
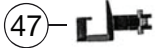
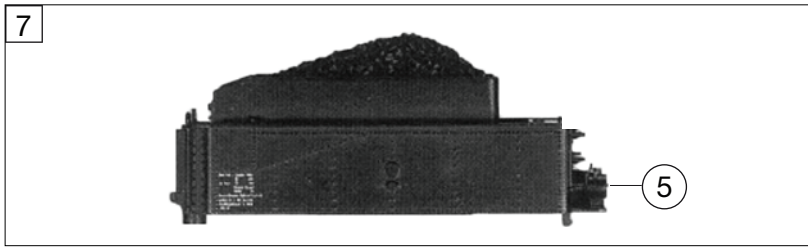

781308		BR 055 DB	=	N
Pos. Nr. Pos.no.	Beschreibung Description	Art.-Nr. Art.no.	Preisgruppe Price bracket	
35	SCHRAUBE M 1,4 X 3 Screw M 1,4 x 3	00700203	001	
36	SCHRAUBE M 1,7 X 6 Screw M 1,7 x 6	00700306	001	
37	SCHRAUBE Screw	00702903	001	
38	BOLZEN F. KUPPELSTANGE - N - Bolt for coupling rod	00730523	002	
39	BOLZEN F. ZAHNRAD Bolt for gear wheel	00730546	002	
40	STECKPUFFER (GEWÖLBT) Plug-in buffer (curved)	00757011	002	
41	STECKPUFFER (FLACH) Plug-in buffer (flat)	00757012	002	
42	BLATTRICHTFEDER F.KUPPLUNG N Flat straightening spring for coupling	00767006	001	
43	DRUCKFEDER Pressure spring	00767012	001	
44	ERSATZ-SCHLEIFKOHLEN Carbon brushes set	6518	---	
45	ERS.-GLUEHLAMPE KLAR M.STECKFA Replacement bulb, clear, with plug-in socket	00006535	008	
46	STANDARD-KUPPLUNG Standard coupling	9521	---	
47	STANDARD-STECKKUPPLUNG Clip-in coupling	9525	---	
48	PROFI-KUPPLUNG Profi coupling	9541	---	
49	PROFI-STECKKUPPLUNG Profi clip-in coupling	9545	---	