

781383		G.8.1	K.P.E.V.	ESSEN 4967	DCC	=	N
Pos. Nr. Pos.no.	Beschreibung Description	Art.-Nr. Art.no.	Preisgruppe Price bracket				
1	LOKGEHÄUSE BR 55 DB EP III Loco body assembly	10781383	031				
2	LICHTLEITER Running board	00137155	006				
3	PFEIFE Whistle	00197605	004				
4	GASLATERNE VORN Kerosene lamp front	00197803	007				
5	GASLATERNE HINTEN Kerosene lamp rear	00197804	007				
6	TENDERGEHÄUSE KPL. Tender body complete	20781383	---				
7	TENDERBODENRAHMEN KPL. Tender framework bottom side complete	21715481	023				
8	LOKFAHRGEST.KPL. BR 55 DB EP III Loco chassis complete	30781383	---				
9	LOKFAHRGEST.M. RAEDERN, KUPPELST Loco chassis with wheel, coupling rod	31715401	032				
10	KREUZKÖPFE U. KUPPELSTANGENSATZ Cross-head and coupling rod	32715401	017				
11	DECKPLATTE UNTEN F: 780901 AA Lower cover plate	33715401	007				
12	KU-KU DEICHSEL Short coupling reception	00347155	005				
13	ADAPTER F. DAMPFLOKS Adaptor for loco steam	38701600	006				
14	TENDERFAHRGESTELL O.MOT. BR 55 Tender chassis w/o motor	40715481	033				
15	TENDERFAHRGESTELL M.Z. Tender chassis complete w/ tongue (trac. Tyre)	41715401	024				
16	MOTOR Motor	50715581	028				
17	KOHLEHALTER Carbon brush holder	00507802	003				
18	MOTORHALTEBUEGEL Motor retainer clip	00507901	002				
19	TENDERRAD O.Z.M.N.ISO. Tender wheelset w/o gear, with trac. tyre, isul.	51709900	008				
20	TENDERRAD O.Z.O.N.ISO. Tender wheelset w/o gear, w/o trac. tyre, isul.	51710000	008				
21	KUPPELRAD Coupled wheelset.	51709600	006				
22	LOKRAD N.H.UGR. Loco wheel small counterweight insul.	51709500	007				
23	TREBRAD LINKS Driving wheel left side	51709700	007				
24	TREBRAD RECHTS ISOL. Driving wheel right side isolated	51709800	008				
25	ACHSE Axle	00527007	001				
26	HAFTREIFEN Traction tyre	00547001	001				
27	ZAHNRAD Z:13 SCHW.VERN. Gear wheel nickel-plated	00567123	006				
28	ZAHNRAD Z:12/8 ROT Gear wheel	00567141	002				
29	ZAHNRAD Z:12/8 BRAUN Gear wheel	00567142	002				
30	SCHNECKE D = 4MM L = 5MM Worm	00567601	007				
31	STROMABNEHMEREINSATZ KPL. BR 55 Power pick-up assembly complete	60781383	---				
32	HALTEPLATTE F.87086 Cover plate	00627086	003				
33	ENTSTOERKONDENSATOR Anti-noise capacitor	64420900	005				
34	SCHRAUBEM 1,4 X 3 Screw	00700203	001				

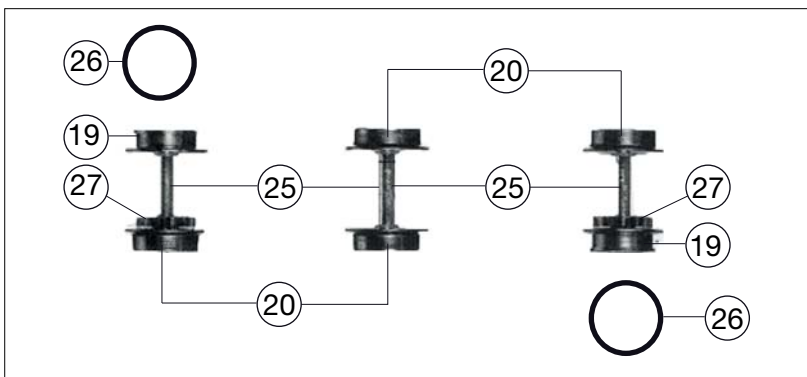

Pos. Nr. Pos.no.	Beschreibung Description	Art.-Nr. Art.no.	Preisgruppe Price bracket
35	SCHRAUBE Screw	00700306	001
36	SCHRAUBE Screw	00702903	001
37	BOLZEN F.ZAHNRAD Bolt for gear wheel	00730546	002
38	BOLZEN F.KUPPELSTANGE Bolt for coupling rod	00730562	002
39	STECKPUFFER (GEWÖLBT) Plug-in buffer, curved	00757011	002
40	STECKPUFFER (FLACH) Plug-in buffer, flat	00757012	002
41	BLATTFRICHTFEDER F.KUPPLUNG N Flat straightening spring for coupling	00767006	001
42	DRUCKFEDER F.LOK-TENDER-KUJU Pressure spring for loco tender	00767012	001
43	ERSATZ-SCHLEIFKOHLEN Carbon brushes set	6518	—
44	ERS-GLUEHLAMPE KLARM.STECKFA Replacement bulb, clear, with plug-in socket	00006535	008
45	STANDARD-KUPPLUNG Standard coupling	9521	—
46	STANDARD-STECKKUPPLUNG Standard plug-in coupling	9525	—
-	PROFI-KUPPLUNG Profi coupling	9541	—
-	PROFI-STECKKUPPLUNG Profi-plug-in coupling	9545	—
-	Leiterplatte kpl. (o. Abb.) PCB complete (w/o illustr.)	65717100	—
-	Lokempfänger DCC (RailCom) "N" (o.Abb.) Decoder DCC (RailCom) type N (w/o illustr.)	68781383	—

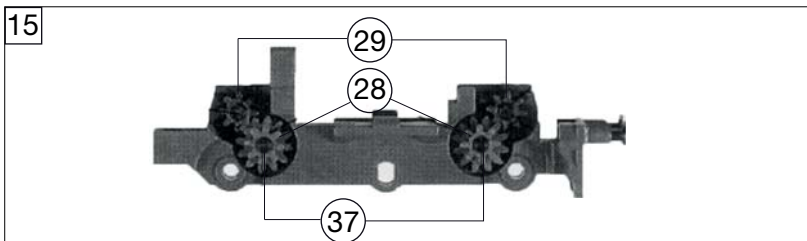
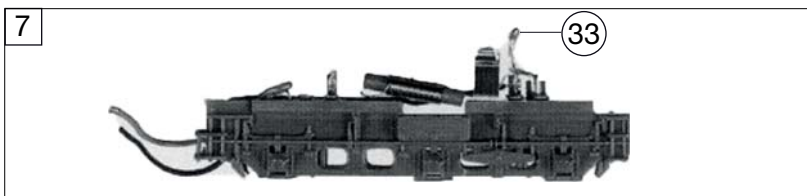
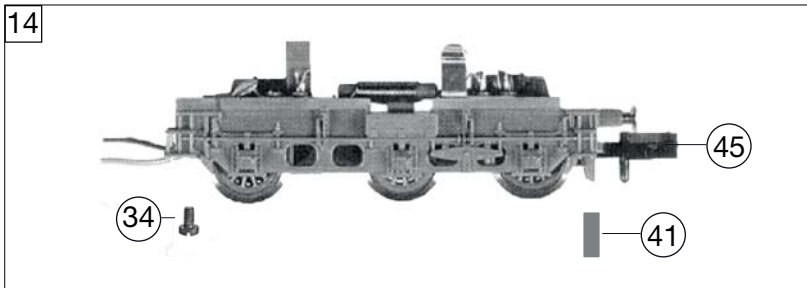
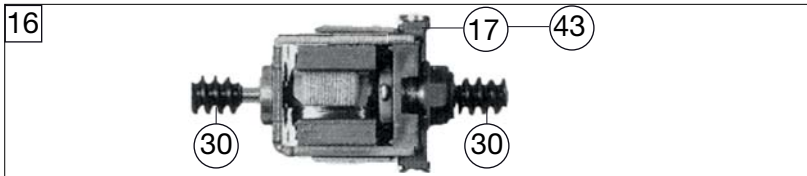
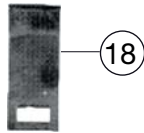
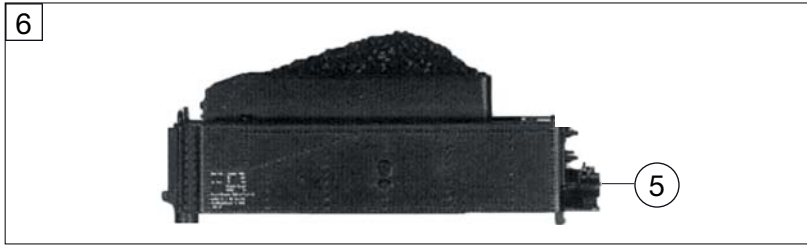