

781384		BR 55.25-56	DB	DCC	=	N
Pos. Nr. Pos.no.	Beschreibung Description	Art.-Nr. Art.no.	Preisgruppe Price bracket			
1	LOKGEHÄUSE KPL. Loco body assembly	10781384	031			
2	FLUTLICHTLEITER Light conductor	00137155	006			
3	PFEIFE BRÜN. Whistle	00197605	004			
4	LATERNE WEISS Lamp white	00197806	009			
5	LATERNE HINT.WEISS Rear lamp white	00197808	008			
6	TENDERGEHÄUSE KPL.f. 781384 Tender body complete	20781384	024			
7	TENDERBODENRAHMEN KPL. Tender framework complete	21715581	023			
8	LOKFAHRGEST.KPL Loco chassis complete	30781384	040			
9	LOKFAHRGEST.M.RAEDERN Loco chassis complete with wheels	31781384	032			
10	KREUZKÖPFE U. KUPPELSTANGEN SATZ Cross-heads and coupling rods set	32715401	017			
11	DECKPLATTE UNTEN Lower cover plate	00337155	007			
12	KUKU DEICHSEL Short coupling reception	00347155	005			
13	ADAPTER F.DAMPFLOKS Adaptor for loco steam	00387003	007			
14	TENDERFAHRGESTELL KPL.O.MOT. Tender chassis complete w/o motor	40715581	033			
15	TENDERFAHRGESTELL M.ZAHNRÄDER Tender chassis with gear wheels	00417155	024			
16	MOTOR Motor	50715581	028			
17	KOHLENROHR Brush pipe	00507802	003			
18	MOTORHALTEBUEGEL SCHW.VERN. Motor retainer clip black	00507901	002			
19	TENDERRAD O.Z.M.N.ISO.ROT Tender wheelset w/o gear, with trac. tyre, isul.	00517003	006			
20	TENDERRAD O.Z.O.N.ISO.ROT Tender wheelset w/o gear, w/o trac. tyre, isul.	00517013	007			
21	LOKRAD N.H.UGR Loco wheel small counterweight insul.	00517044	006			
22	KUPPELRAD Coupled wheel	00517063	007			
23	TREIBRAD LINKS Left driving wheel	00517064	007			
24	TREIBRAD RECHTS Right driving wheel	00517065	007			
25	ACHSE Axle	00527007	001			
26	HAFTREIFEN Traction tyre	00547001	001			
27	ZAHNRAD Z:13 SCHW.VERN. Gear wheel Z=13 black nickel-plated	00567123	006			
28	ZAHNRAD Gear wheel	00567141	002			
29	ZAHNRAD Gear wheel	00567142	002			
30	SCHNECKE D = 4MM L = 5MM Worm gear D=4mm, L=5mm	00567601	007			
31	STROMABNEHMEREINSATZ KPL Power pick-up assembly	60781384	031			
32	HALTEPLATTE F.DIGITAL Mounting plate for digital	00627086	003			
33	KONDENSATOR Capacitor	64420900	005			
34	SCHRAUBE M 1,4 X 3 Screw M 1,4 X 3	00700203	001			
	LEITERPLATTE KPL (o. Abb.) PCB complete (w/o illustr.)	65717100	030			
	LOKEMPFÄNGER DCC (RAILCOM)N (o. Abb.) N gauge DCC-decoder (railCom) (w/o illustr.)	68781383	041			

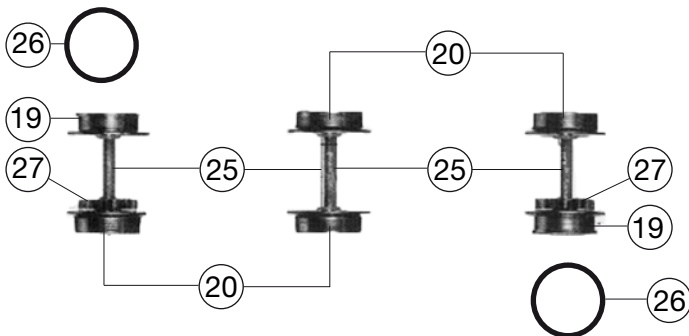

781384		BR 55.25-56	DB	DCC	=	N
Pos. Nr. Pos. no.	Beschreibung Description	Art.-Nr. Art. no.	Preisgruppe Price bracket			
35	SCHRAUBE M 1,7x6 Screw M 1,7x6	00700306	001			
36	SCHRAUBE Screw	00702903	001			
37	BOLZEN F.ZAHNRAD Bolt for gear wheel	00730546	002			
38	BOLZEN F.KUPPELSTANGE Bolt for coupling rod	00730523	002			
39	STECKPUFFER (GEWÖLBT) Plug-in buffer, curved	00757011	002			
40	STECKPUFFER (FLACH) Plug-in buffer, flat	00757012	002			
41	BLATTRICHTFEDER F.KUPPLUNG N Flat straightening spring for coupling	00767006	001			
42	DRUCKFEDER Pressure spring	00767012	001			
43	ERSATZ-SCHLEIFKOHLEN Carbon brushes set	6518	---			
44	ERS.-GLUEHLAMPE KLAR M.STECKFA Replacement bulb, clear, with plug-in socket	00006535	008			
45	STANDARD-KUPPLUNG Standard coupling	9521	---			
46	STANDARD-STECKKUPPLUNG Standard clip-in coupling	9525	---			
47	PROFI-KUPPLUNG Profi coupling	9541	---			
48	PROFI STECKKUPPLUNG Profi clip-in coupling	9545	---			

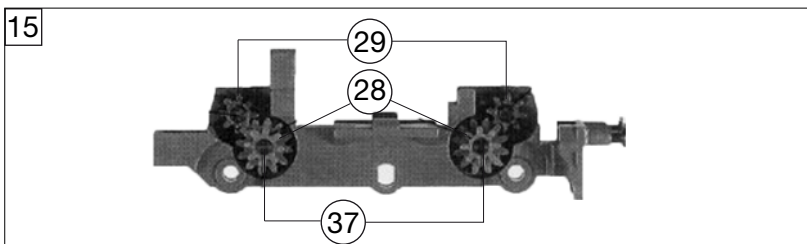
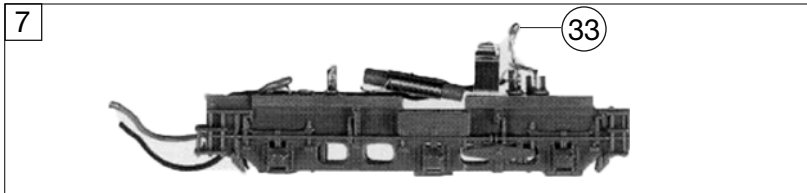
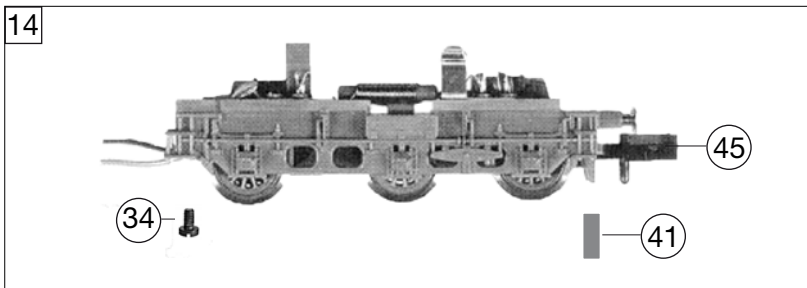
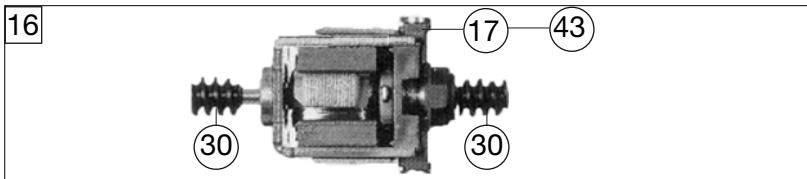
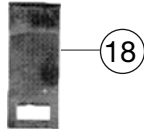
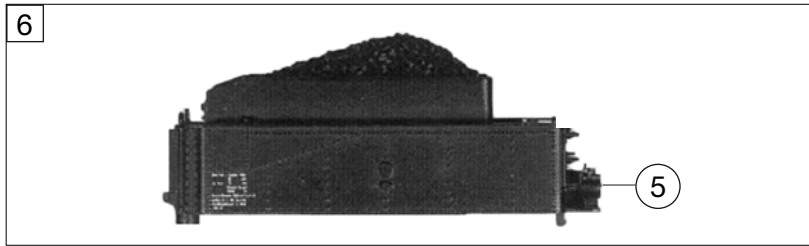