

781388		BR 055 DB	☐ = N
Pos. Nr. Pos.no.	Beschreibung Description	Art.-Nr. Art.no.	Preisgruppe Price bracket
1	LOKGEHÄUSE KPL. F.781308 BR 55 Body assembly complete for 781308	10781308	031
2	FLUTLICHTLEITER Light conductor	00137155	006
3	PFEIFE BRÜN. Loco whistle	00197605	004
4	LAMPE EL. VORN Front lamp	00197812	005
5	LAMPE EL. HINTEN Back lamp	00197813	005
6	ANTENNE SCHW. VERN. Antenna black,nickel-plated	19784700	003
7	TENDERGEHÄUSE KPL. F.781308 Tender body complete for 781308	20781308	024
8	TENDERBODENRAHMEN KPL.F.781388 Tender framework	21781388	023
9	LOKFAHRGESTELL KPL. F.781388 Loco chassis complete	30781388	040
10	LOKFAHRGEST.M.RAEDERN,KUPPELST Loco chassis w.gear wheels and coupling rod	31715501	032
11	KREUZKÖPFE U. VERBUNDSTANGEN Cross-heads and coupling rods	32715501	017
12	DECKPLATTE UNTEN Lower cover plate	00337155	007
13	KUKU-DEICHSEL Short coupling reception	00347155	005
14	ADAPTER F.DAMPFLOKS Adaptor for steam loco	00387003	007
15	TENDERFAHRGESTELL KPL.o.Motor Tender chassis complete w/o motor	40781388	033
16	TENDERFAHRGESTELL MIT ZAHNRÄDE Tender chassis with gear wheels	00417154	024
17	MOTOR Motor	50715581	028
18	KOHLENROHR Brush pipe	00507802	003
19	MOTORHALTEBÜGEL SCHW. VERN. Motor retainer clip black,nickel-plated	00507901	002
20	TENDERRAD O.Z.M.N.ISO.ROT Tender wheelset w/o gear wheel ,w.tract.tyre	00517003	006
21	TENDERRAD O.Z.O.N.ISO.ROT Tender wheelset w/o gear wheel ,w/o tract.tyre	00517013	007
22	LOKRAD N.H.UGR. Loco wheel small counterweight insul.	00517044	006
23	KUPPELRAD Coupled wheel	00517063	007
24	TREIBRAD LI. Driving wheel left	00517064	007
25	TREIBRAD RE. Driving wheel right	00517065	007
26	ACHSE Axle	00527007	001
27	HAFTREIFEN Traction tyre	00547001	001
28	ZAHNRAD Z:13 SCHW.VERNICKELT Gear wheel Z=13 black,nickel-plated	00567123	006
29	ZAHNRAD Gear wheel	00567141	002
30	ZAHNRAD Gear wheel	00567142	002
31	SCHNECKE D = 4MM L = 5MM Worm gear D=4mm, L=5mm	00567601	007
32	STROMABNEHMEREINSATZ KPL. Power pick-up assembly	60781388	031
33	HALTEPLATTE FÜR DIGITAL Mounting plate for digital	00627086	003
	LEITERPLATTE KPL. (o.Abb.) PCB complete (w/o Illustration)	65717100	030
	LOKEMPFFÄNGER DCC (RailCom) *N* (o.Abb.) N gauge DCC-decoder (railCom) (w/o Illustr.)	68781383	041
36	SCHRAUBE M 1,4 X 3 Screw M 1,4 x 3	00700203	001

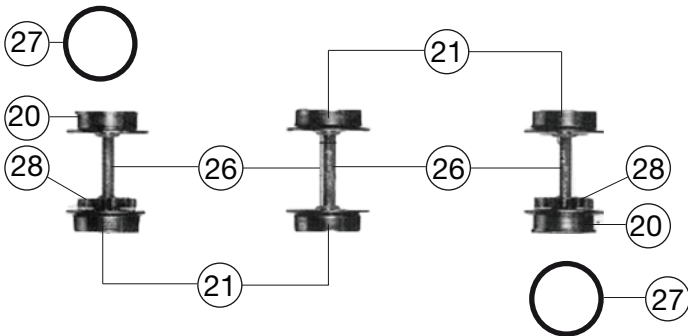
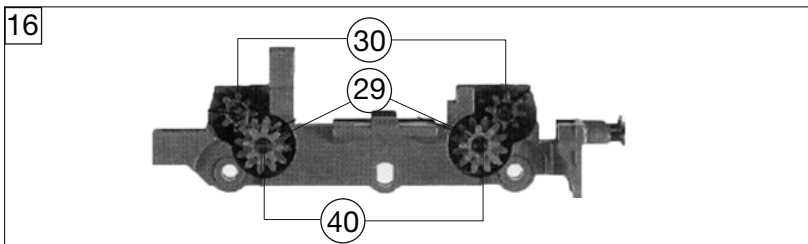
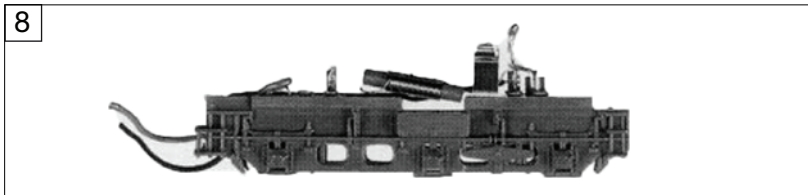
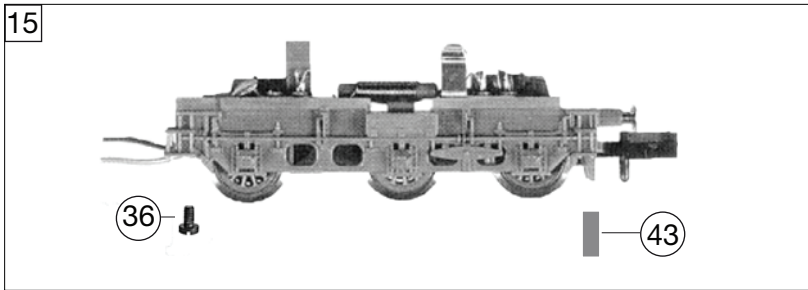
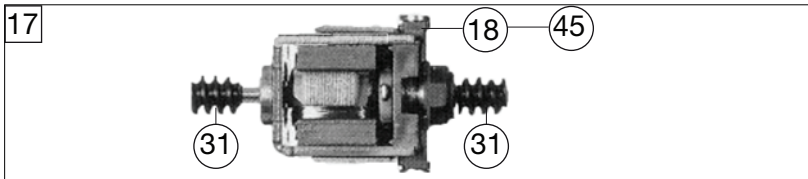
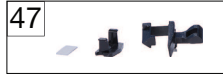
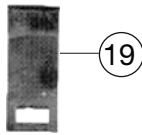
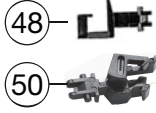
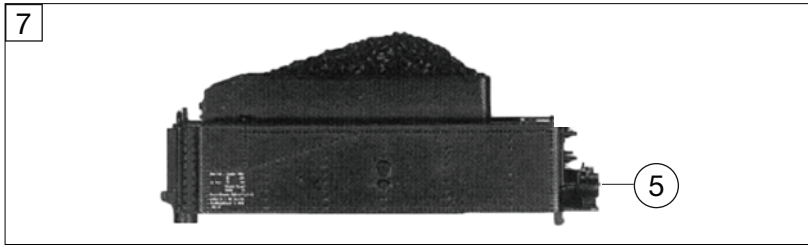

781388		BR 055 DB	☐ = N
Pos. Nr. Pos.no.	Beschreibung Description	Art.-Nr. Art.no.	Preisgruppe Price bracket
37	SCHRAUBE M 1,7 X 6 Screw M 1,7 x 6	00700306	001
38	SCHRAUBE Screw	00702903	001
39	BOLZEN F. KUPPELSTANGE - N - Bolt for coupling rod	00730523	002
40	BOLZEN F. ZAHNRAD Bolt for gear wheel	00730546	002
41	STECKPUFFER (GEWÖLBT) Plug-in buffer (curved)	00757011	002
42	STECKPUFFER (FLACH) Plug-in buffer (flat)	00757012	002
43	BLATTRICHTFEDER F.KUPPLUNG N Flat straightening spring for coupling	00767006	001
44	DRUCKFEDER Pressure spring	00767012	001
45	ERSATZ-SCHLEIFKOHLEN Carbon brushes set	6518	---
46	ERS.-GLUEHLAMPE KLAR M.STECKFA Replacement bulb, clear, with plug-in socket	00006535	008
47	STANDARD-KUPPLUNG Standard coupling	9521	---
48	STANDARD-STECKKUPPLUNG Clip-in coupling	9525	---
49	PROFI-KUPPLUNG Profi coupling	9541	---
50	PROFI-STECKKUPPLUNG Profi clip-in coupling	9545	---