

867386		=		N
Pos. Nr. Pos.no.	Beschreibung Description	Art.-Nr. Art.no.	Preisgruppe Price bracket	
1	Lokgehäuse komplett Body assembly complete			
2	Lichtleiter mit Führerstand-Satz Optical fiber with driver's cab-set	00137385	011	
3	Fensterblenden Satz Window set	00147320	017	
4	Signalhorn Satz Signal horn set	00197618	011	
5	Antenne lang Aerial long	00197802	002	
6	Antenne kurz Aerial short	00197824	002	
7	Schienenräumer Satz Track sweeper set	00227385	012	
8	Zugkraftanlenkung Satz Drag force direction set	02273201	009	
9	Armaturenteil Armature frame	00337385	009	
10	Kuku Deichsel Short coupling shaft	00387006	005	
11	Lokfahrgestell ohne Motor Loco chassis w/o motor	00407385	019	
12	Drehgestellrahmen Bogie frame	00417385	011	
13	Deichselabdeckung Satz Cover set	00437320	009	
14	Drehgestellblock kpl. Bogie gear box complete	00457320	018	
15	Motor mit Schwungmasse Motor with flywheel mass	00507356	030	
16	Kohlenhalter Carbon brush holder	00507801	001	
17	Achse für Zahnrad Shaft for gear	00527009	001	
18	Achse zur Drehgestellbefestigung Shaft for bogie	00527010	001	
19	Radsatz komplett, mit Zahnrad, ohne Nut Wheelset, with gear, w/o groove	00537067	015	
20	Radsatz komplett, mit Zahnrad, mit Nut Wheelset, with gear, with groove	00537068	015	
21	Haftreifen Traction tyre	00547002	001	
22	Zahnrad Z:13 schwarz Gear black	00567149	006	
23	Schnecke D= 4mm, L= 8mm Worm	00567604	006	
24	Kontaktband Contact band	00617916	001	
25	Umschalter Switch	00647320	012	
26	Leiterplatte unten, kpl. mit Schnittstelle PCB down, complete with interface (NMRA)	00657092	023	
27	Leiterplatte oben I PCB up I	00657093	018	
28	Leiterplatte oben II PCB up II	00657094	017	
29	Stecker für Schnittstelle Dummy plug	00664002	013	
30	Ersatz-Schleifkohlen Carbon brush holder	6518		

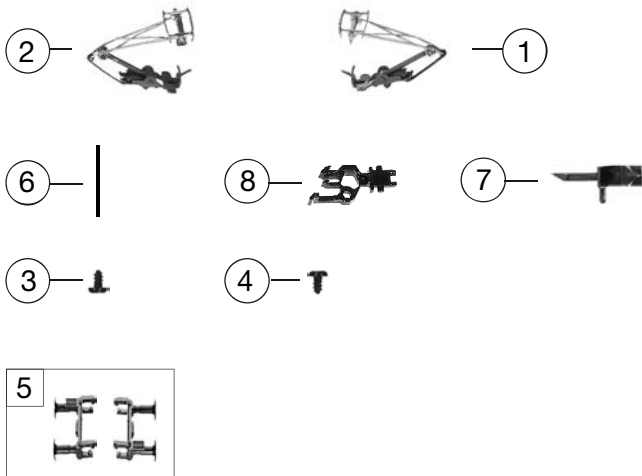

867386		==	N
Pos. Nr. Pos.no.	Beschreibung Description	Art.-Nr. Art.no.	Preisgruppe Price bracket
1	Einholmstromabnehmer, kurzer Schleifer Pantograph, short bow	00677023	021
2	Einholmstromabnehmer langer Schleifer Pantograph, long bow	00677024	021
3	KS-Schraube Cross head screw	00704903	001
4	Linsenschraube M 1,6x4 Lens head screw M 1,6x4	00704904	002
5	Pufferbohlen Satz Headstock set	00757322	009
6	Richtfeder für Deichsel Spring for coupler	00767008	001
7	Standard-Kupplung Standard coupler	9525	
8	Profi-Kupplung Profi coupler	9545	