

708683		DB	BR 86	=	N
Pos. Nr. Pos.no.	Beschreibung Description	Art.-Nr. Art.no.	Preisgruppe Price bracket		
1	LOKGEHÄUSE KPL. Loco chassis complete	10708683	034		
2	LICHTLEITER-SATZ Light conductor set	00137086	011		
3	HALTESTANGE Handrail	00197702	003		
4	FAHRGESTELL KPL. OHNE MOTOR Chassis with gear set complete w/o motor	40708683	038		
5	FAHRGESTELL M.LOK.-ZAHNRÄDER U Chassis with loco, gear wheel	41708603	032		
6	STEUERUNG KPL. MIT KUPPELSTANG Reversing gear complete with coupling rod	42708601	028		
7	ABDECKPLATTE UNTEN Cover plate bottom side	04370861	006		
8	VORLAUFGESTELL M.KUPPLUNG Bogie with coupling	00477086	016		
9	ZYLINDERKASTEN F.7086/7087 Cylinderbox	00487087	016		
10	NACHLAUFGESTELL M.KUPPLUNG Set of carrying wheels w/o coupling	00497086	016		
11	MOTOR M.SCHW.O.MASSEKONTAKT Motor with flywheel w/o ground contactor	00507086	029		
12	KOHLEHALTER Carbon brush holder	00507802	003		
13	MOTORHALTEBUEGEL Motor support plate	00507901	002		
14	TREIBRAD LINKS M.N. Driving wheel left side with tongue	00517060	007		
15	KUPPELRAD Coupled wheel set	00517062	007		
16	TREIBRAD RECHTS M.N. Driving wheel right side with tongue	00517087	007		
17	ACHSE Axel	00527007	001		
18	RADSATZ VOR-U.NACHLAUFGESTELL Wheel set complete	00537030	011		
19	HAFTREIFEN Traction tyre	00547002	001		
20	ZAHNRAD Z:18 Gear wheel, brass Z:18	00567128	006		
21	ZAHNRAD Z:27/17 Gear wheel Z:27/17	00567140	004		
22	SCHNECKE D = 4MM L = 5MM Worm D = 4MM L = 5MM	00567601	007		
23	STROMABNEHMEREINS.M.LAMP.H. Power pick-up assembly with lamp holder	60708682	024		
24	LAMPENHALTER Lamp support	00637098	009		
25	ENTSTOERDROSSEL Suppressor choke	00644101	007		
26	KONDENSATOR Capacitor	64420900	005		
27	SCHRAUBE M 1,4 X 3 Screw M 1,4 X 3	00700203	001		
28	SCHRAUBE Screw	00702903	001		
29	SENKSCHRAUBE Countersunk screw	00702910	001		
30	BOLZEN F. ZAHNRAD Bolt for gear wheel	00730511	002		
31	BOLZEN F. KUPPELSTANGE Bolt for coupling rod	00730570	001		
32	STECKPUFFER (GEWÖLBT) GESTEMP. Plug-in buffer (curved) stamped	75706600	001		
33	STECKPUFFER (FLACH) GESTEMP. Plug-in buffer (flat) stamped	75706700	003		
34	DRUCKFEDER F.RADSATZ F.7394 Pressure spring for gear wheel	00767014	001		

Änderungen in Konstruktion und Ausführung vorbehalten
We reserve the right to change the construction and specification

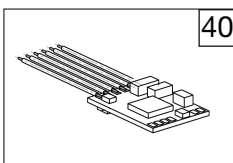
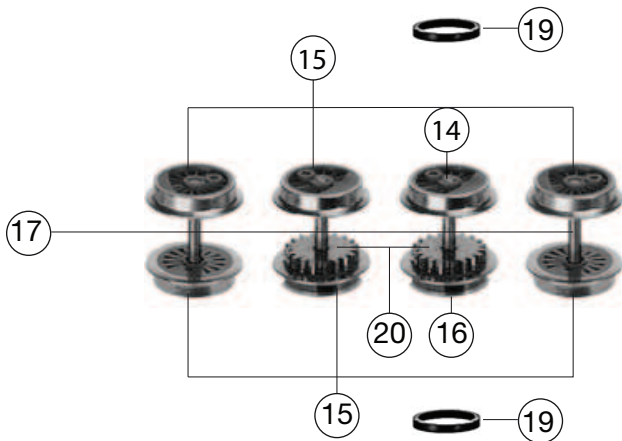
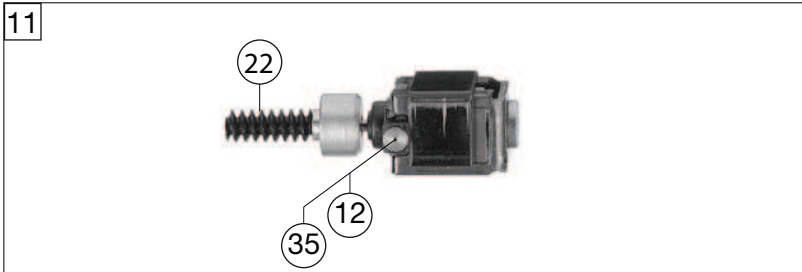
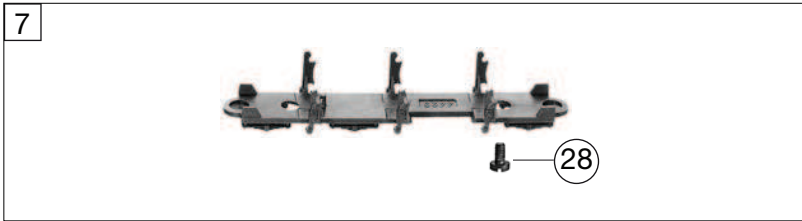

708683		DB	BR 86	=	N
Pos. Nr. Pos.no.	Beschreibung Description	Art.-Nr. Art.no.	Preisgruppe Price bracket		
35	ERSATZ-SCHLEIFKOHLEN Carbon brushes set	6518	---		
36	ERSATZ-GLUEHLAMPE KLAR M.STECKFA Replacement blub clear with plug-in socket	00006535	008		
37	STANDARD-STECKKUPPLUNG Standard clip-in coupling	9525	---		
38	PROFI-STECKKUPPLUNG Profi clip-in coupling	9545	---		
39	HALTEPLATTE FÜR DIGITAL Mounting plate for digital	00627086	003		
40	LOKEMPFÄNGER DCC (RailCom) "N" N gauge DCC-decoder (railCom)	68708781	041		

Ersatzteile erhalten Sie direkt unter www.fleischmann.de, bei Ihrem Fachhändler, oder Ihrer Landesvertretung.
Spare parts can be ordered directly at www.fleischmann.de and from your local dealer or country representative.