

715210	DR	BR 52	=	N
Pos. Nr. Pos.no.	Beschreibung Description		Art.-Nr. Art.no.	Preisgruppe Price bracket
1	LOKGEHÄUSE KPL. Betr. Nr. 52 2608-9 Loco chassis complete no. 52 2608-9		10715210	029
2	UMLAUFBLECH Running board		11715210	025
3	LICHTLEITER Light conductor		13715201	006
4	PFEIFE Whistle		00197605	004
5	LOKFAHRGESTELL KPL. Loco chassis complete		30715210	040
6	LOKFAHRGESTELL MIT RÄDERN Loco chassis with wheels		31715210	032
7	STEUERUNG KPL. MIT KUPPELSTANGEN Reversing gear complete with coupling rod		32715201	017
8	ABDECKPLATTE UNTEN Cover plate bottom		00337181	006
9	VORLAUFGESTELL KPL. Carrying wheel		00377182	017
10	KUPPELLASCHE LOK-TENDER Coupling latch loco tender		38802100	004
11	ZYLINDERKASTEN KPL. BR 52 Cylinder box complete BR 52		48715201	013
12	KUPPELRAD Coupled wheel		00517062	007
13	TREIBRAD LINKS Driving wheel left		00517072	008
14	TREIBRAD RECHTS Driving wheel right		00517073	008
15	KUPPELRAD Cupled wheel		00517074	008
16	ACHSE Axle		00527007	001
17	VORLAUFRADSATZ, SCHEIBENRADSATZ KPL. Carrying wheelset cpl., disc wheelset cpl.		00537066	012
18	LEITERPLATTE KPL. PCB complete		65714100	022
19	LEITERPLATTE KPL. PCB complete		65714200	022
20	STECKER FÜR SCHNITTSTELLE 6-POL Jumper 6-pin		00664005	013
21	LINSENSCHRAUBE M1,6x2-4,8 H Button screw M1,6x2-4,8 H		00704902	002
22	LINSENSCHRAUBE M1,6x4 MIT KREUZ- SCHLITZ Button screw M1,6x4 with cross-slot		00704904	002
23	BLECHSCHRAUBE MIT KREUZSCHLITZ Tapping screw		00713309	001
24	BOLZEN FÜR KUPPELSTANGE Bolt for coupling rod		00730562	002
25	BOLZEN FÜR KUPPELSTANGE Bolt for coupling rod		00730570	001
26	STECKPUFFER (GEWÖLBT) Plug-in buffer (curved)		00757011	002
27	STECKPUFFER (FLACH) Plug-in buffer (flat)		00757012	002
28	ZUGFEDER SCHWARZ Draw spring black		76710800	001
29	FEDERBÜGEL FÜR ZUGFEDER Spring clip for draw spring		76711000	001

Änderungen in Konstruktion und Ausführung vorbehalten  
We reserve the right to change the construction and specification

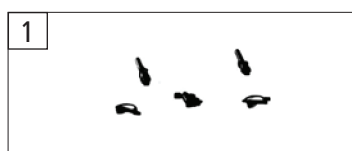
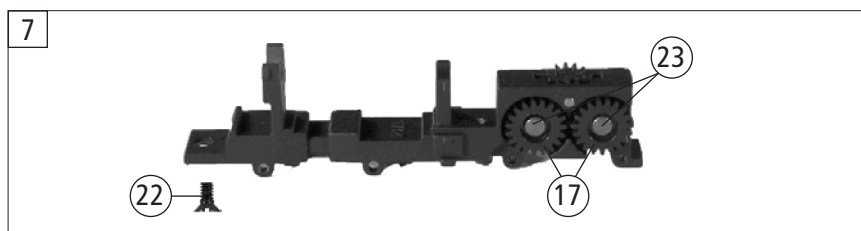
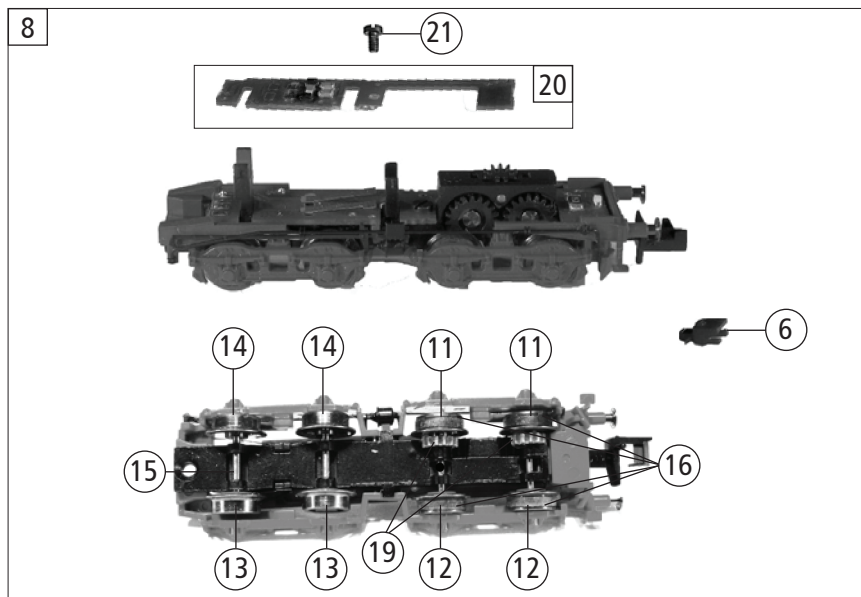
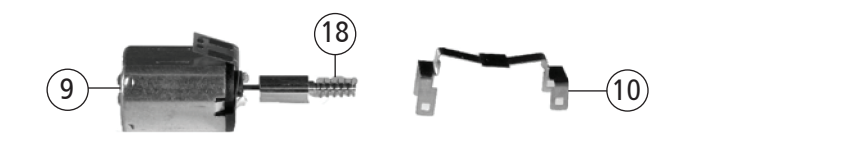
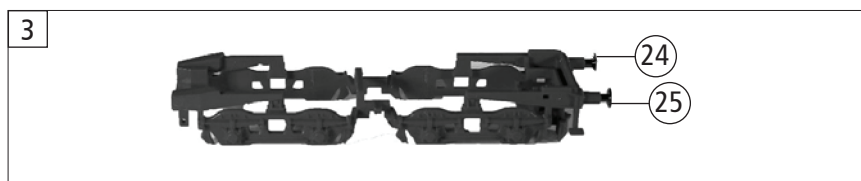
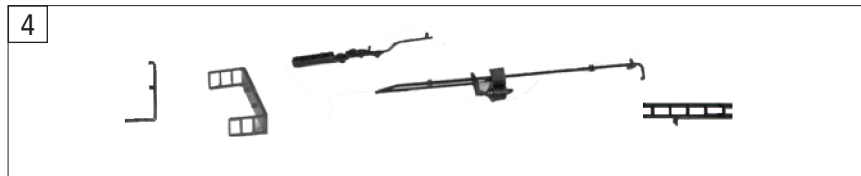
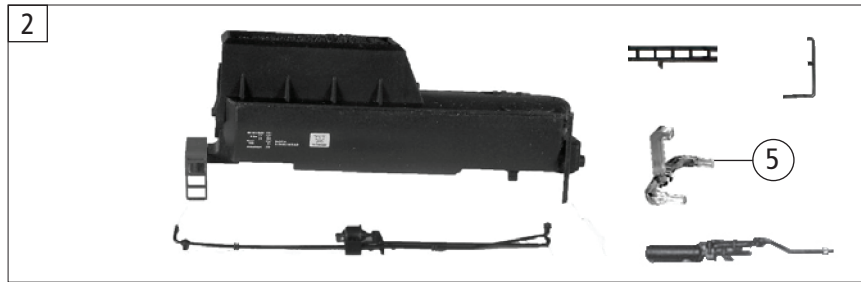

715210	DR	BR 52	=	N
Pos. Nr. Pos.no.	Beschreibung Description		Art.-Nr. Art.no.	Preisgruppe Price bracket
1	ZUGHAKEN-BREMSKUP.-KOLBENSTANGE Coupling hook, brake coupling, piston rod		19715201	012
2	TENDERGEHÄUSE KPL. Betr. Nr. 52 2608-9 Tender body complete no. 52 2608-9		20715210	024
3	TENDERRAHMEN KPL. Tender framework complete		21715210	023
4	LEITER-TREPPE-HANDLAUF-ROHRLEITUNG Ladder-treadle-handrail-pipe		22715201	011
5	LICHTLEITER FÜR TENDER Light conductor for tender		23715201	006
6	ADAPTER Adaptor		00387008	006
7	TENDERFAHRGESTELL MIT ZAHNRÄDER Tender chassis with gears		41715201	027
8	TENDERFAHRGESTELL KPL. OHNE MOTOR Tender chassis complete w/o motor		40715210	033
9	MOTOR Motor		50715201	030
10	MOTORHALTEBÜGEL Motor retainer clip		50791400	002
11	TENDERRAD M.N. ROT LACK. Tender wheel with traction tyre		51713500	007
12	TENDERRAD M.N. ROT LACK. UGR Tender wheel with traction tyre, insulated		51713600	007
13	TENDERRAD O.N. ROT LACK. UGR Tender wheel w/o traction tyre, insulated		51713700	004
14	TENDERRAD O.N. ROT LACK. Tender wheel w/o traction tyre		51713800	003
15	ACHSE Axle		52701200	001
16	HAFTREIFEN Traction tyre		00547001	001
17	ZAHNRAD Gear wheel		56718100	003
18	SCHNECKE (MESSING) Worm gear		56762200	009
19	RITZEL Gear wheel		56762000	001
20	LEITERPLATTE KPL. (TENDER) PCB complete (tender)		65714000	018
21	SCHRAUBE M 1,4 X 3 Screw		00700203	001
22	SCHRAUBE Screw		00702304	001
23	BUNDBOLZEN Flanged bolt		00730578	003
24	STECKPUFFER (GEWÖLBT) Plug-in buffer (curved)		00757011	002
25	STECKPUFFER (FLACH) Plug-in buffer (flat)		00757012	002
	STANDARD-KUPPLUNG (ohne Abb.) Standard coupling (no ill.)		9521	---
	STANDARD-STECKKUPPLUNG (ohne Abb.) Standard clip in coupling (no ill.)		9525	---
	PROFI-KUPPLUNG (ohne Abb.) Profi coupling (no ill.)		9541	---
	PROFI-STECKKUPPLUNG (ohne Abb.) Profi clip in coupling (no ill.)		9545	---

Ersatzteile erhalten Sie direkt unter [www.fleischmann.de](http://www.fleischmann.de), bei Ihrem Fachhändler, oder Ihrer Landesvertretung.  
Spare parts can be ordered directly at [www.fleischmann.de](http://www.fleischmann.de) and from your local dealer or country representative.