

29 o. Abb. / no ill.
SOUND-DECODER
Sound decoder

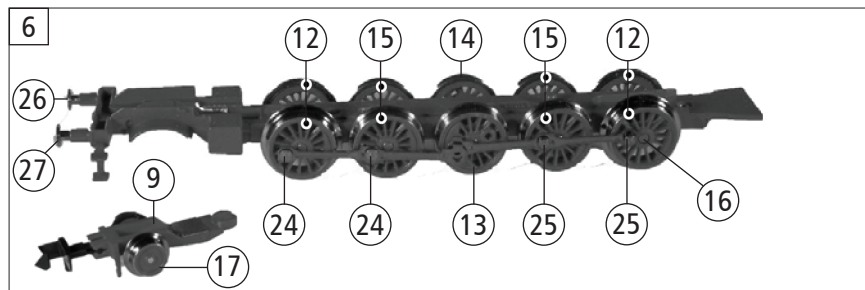

Pos. Nr. Pos.no.	Beschreibung Description	Art.-Nr. Art.no.	Preisgruppe Price bracket
1	LOKGEHÄUSE KPL. Betr. Nr. 52 2608-9 Loco chassis complete no. 52 2608-9	10715290	029
2	UMLAUFBLECH Running board	11715210	025
3	LICHTLEITER Light conductor	13715201	006
4	PFEIFE Whistle	00197605	004
5	LOKFAHRGESTELL KPL. Loco chassis complete	30715290	040
6	LOKFAHRGESTELL MIT RÄDERN Loco chassis with wheels	31715210	032
7	STEUERUNG KPL. MIT KUPPELSTANGEN Reversing gear complete with coupling rod	32715201	017
8	ABDECKPLATTE UNTEN Cover plate bottom	00337181	006
9	VORLAUFGESTELL KPL. Carrying wheel	00377182	017
10	KUPPELLASCHE LOK-TENDER Coupling latch loco tender	38802100	004
11	ZYLINDERKASTEN KPL. BR 52 Cylinder box complete BR 52	48715201	013
12	KUPPELRAD Coupled wheel	00517062	007
13	TREIBRAD LINKS Driving wheel left	00517072	008
14	TREIBRAD RECHTS Driving wheel right	00517073	008
15	KUPPELRAD Cupled wheel	00517074	008
16	ACHSE Axle	00527007	001
17	VORLAUFRADETSATZ, SCHEIBENRADETSATZ KPL. Carrying wheelset cpl., disc wheelset cpl.	00537066	012
18	LEITERPLATTE KPL. PCB complete	65714100	022
19	LAUSPRECHER 8x12 Loudspeaker 8x12	68701700	016
20	LAUSPRECHERAUFNAHME UND BÜGEL Loudspeaker record and clip	68701400	016
21	LINSENSCHRAUBE M1,6x2-4,8 H Button screw M1,6x2-4,8 H	00704902	002
22	LINSENSCHRAUBE M1,6x4 MIT KREUZ- SCHLITZ Button screw M1,6x4 with cross-slot	00704904	002
23	BLECHSCHRAUBE MIT KREUZSCHLITZ Tapping screw	00713309	001
24	BOLZEN FÜR KUPPELSTANGE Bolt for coupling rod	00730562	002
25	BOLZEN FÜR KUPPELSTANGE Bolt for coupling rod	00730570	001
26	STECKPUFFER (GEWÖLBT) Plug-in buffer (curved)	00757011	002
27	STECKPUFFER (FLACH) Plug-in buffer (flat)	00757012	002
28	ZUGFEDER SCHWARZ Draw spring black	76710800	001
29	SOUND-DECODER (ohne Abb.) Sound decoder (no ill.)	68715271	041

Änderungen in Konstruktion und Ausführung vorbehalten
We reserve the right to change the construction and specification

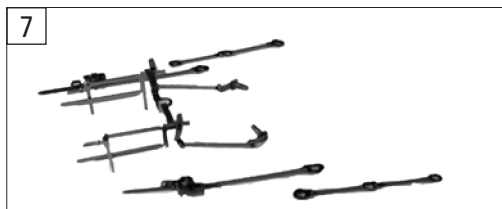
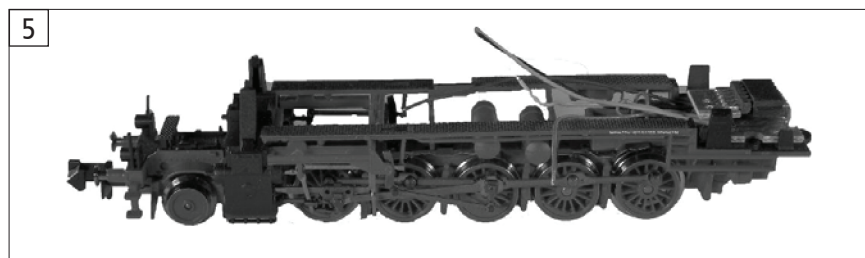
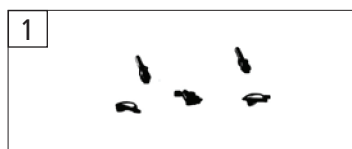
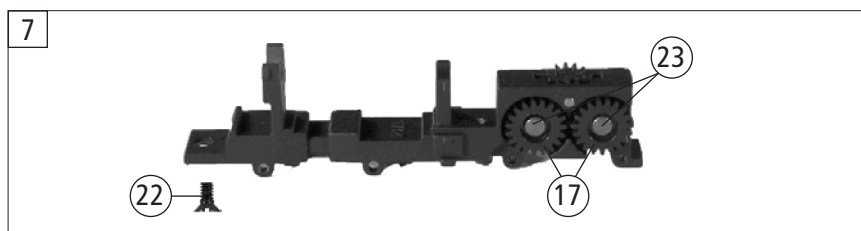
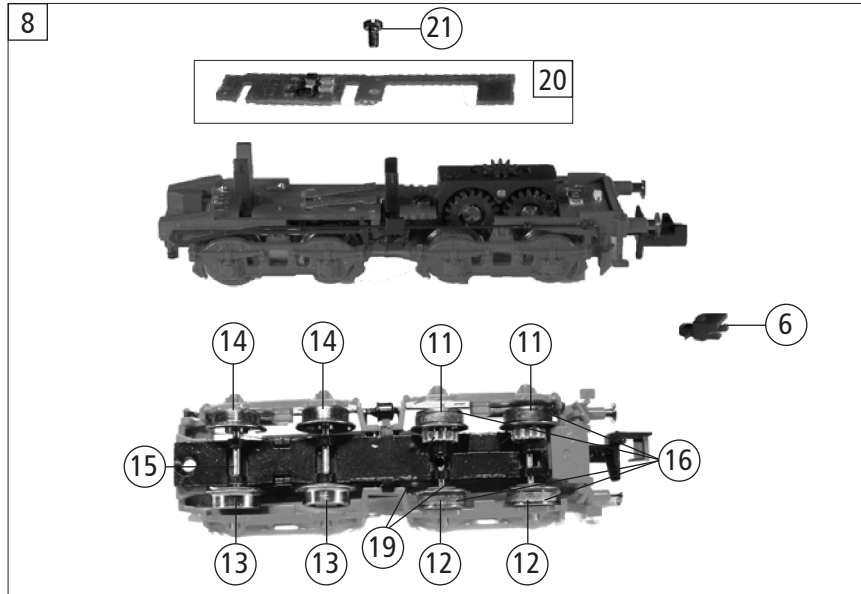
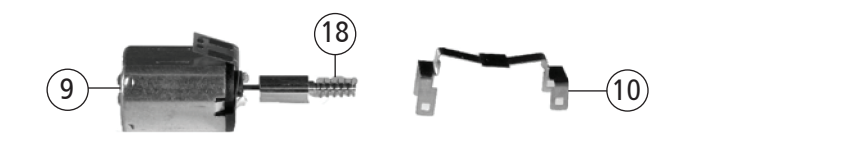
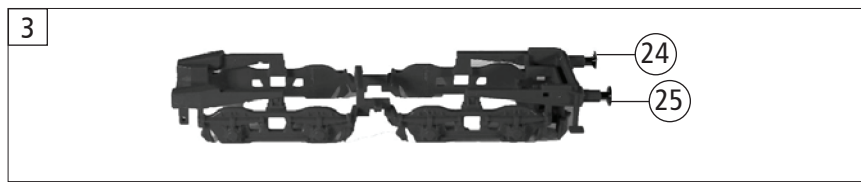
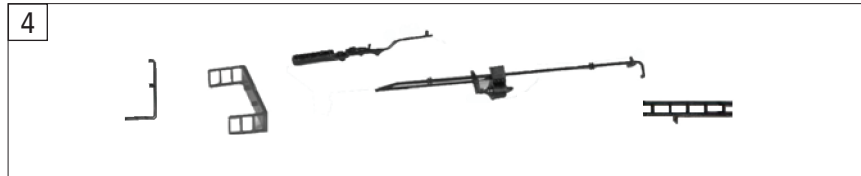
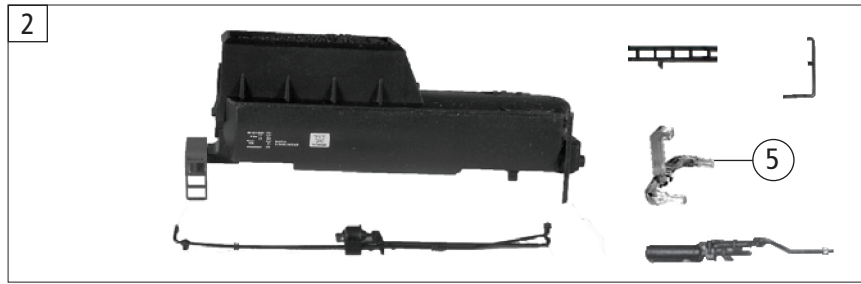

26 o. Abb. / no ill.
BUNDBOLZEN
Flanged bolt

Pos. Nr. Pos.no.	Beschreibung Description	Art.-Nr. Art.no.	Preisgruppe Price bracket
1	ZUGHAKEN-BREMSKUP-KOLBENSTANGE Coupling hook, brake coupling, piston rod	19715201	012
2	TENDERGEHAEUSE KPL. Betr. Nr. 52 2608-9 Tender body complete no. 52 2608-9	20715210	024
3	TENDERRAHMEN KPL. Tender framework complete	21715210	023
4	LEITER-TREPPE-HANDLAUF-ROHRLEITUNG Ladder-treadle-handrail-pipe	22715201	011
5	LICHTLEITER FÜR TENDER Light conductor for tender	23715201	006
6	ADAPTER Adaptor	00387008	006
7	TENDERFAHRGESTELL MIT ZAHNRÄDER Tender chassis with gears	41715201	027
8	TENDERFAHRGESTELL KPL. OHNE MOTOR Tender chassis complete w/o motor	40715290	033
9	MOTOR Motor	50715201	030
10	MOTORHALTEBÜGEL Motor retainer clip	50791400	002
11	TENDERRAD M.N. ROT LACK. Tender wheel with traction tyre	51713500	007
12	TENDERRAD M.N. ROT LACK. UGR Tender wheel with traction tyre, insulated	51713600	007
13	TENDERRAD O.N. ROT LACK. UGR Tender wheel w/o traction tyre, insulated	51713700	004
14	TENDERRAD O.N. ROT LACK. Tender wheel w/o traction tyre	51713800	003
15	ACHSE Axle	52701200	001
16	HAFTREIFEN Traction tyre	00547001	001
17	ZAHNRAD Gear wheel	56718100	003
18	SCHNECKE (MESSING) Worm gear	56762200	009
19	RITZEL Gear wheel	56762000	001
20	LEITERPLATTE KPL. (TENDER) PCB complete (tender)	65714000	018
21	SCHRAUBE M 1,4 X 3 Screw	00700203	001
22	SCHRAUBE Screw	00702304	001
23	BUNDBOLZEN Flanged bolt	00730578	003
24	STECKPUFFER (GEWÖLBT) Plug-in buffer (curved)	00757011	002
25	STECKPUFFER (FLACH) Plug-in buffer (flat)	00757012	002
26	BUNDBOLZEN (ohne Abb.) Flanged bolt (no ill.)	73059800	003
	STANDARD-KUPPLUNG (ohne Abb.) Standard coupling (no ill.)	9521	---
	STANDARD-STECKKUPPLUNG (ohne Abb.) Standard clip in coupling (no ill.)	9525	---
	PROFI-KUPPLUNG (ohne Abb.) Profi coupling (no ill.)	9541	---
	PROFI-STECKKUPPLUNG (ohne Abb.) Profi clip in coupling (no ill.)	9545	---

Ersatzteile erhalten Sie direkt unter www.fleischmann.de, bei Ihrem Fachhändler, oder Ihrer Landesvertretung.
Spare parts can be ordered directly at www.fleischmann.de and from your local dealer or country representative.