

10 ohne Abb./no ill.
SCHILDER-SET
Plates set

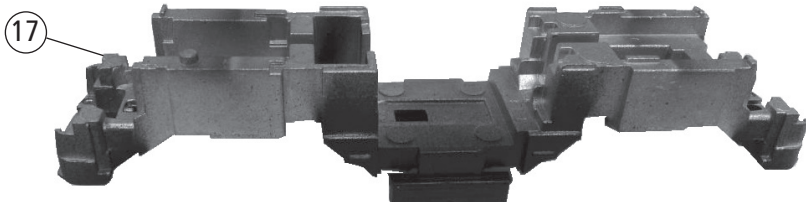
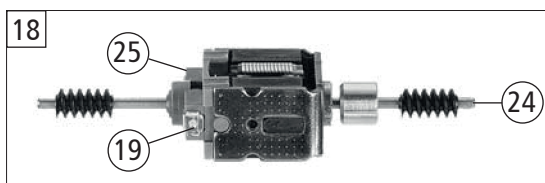
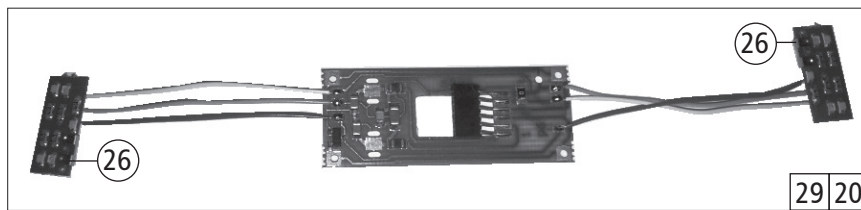
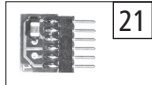
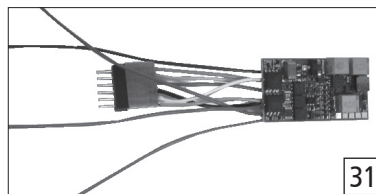
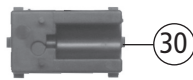
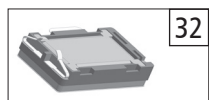
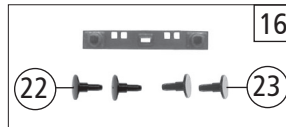
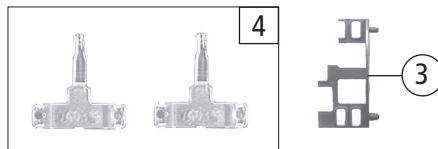

733001	DB	BR 140	=	N
733071			=	🔊

Pos. Nr. Pos.no.	Beschreibung Description	Art.-Nr. Art.no.	Preisgruppe Price bracket
1	LOKGEHÄUSE KPL. Betr. Nr. 140 108-2 Loco body assembly no. 140 108-2	10733001	035
2	LICHTABDECKUNG -SATZ Light cover set	12733001	011
3	LICHTMASKE Light mask	12733803	006
4	LICHTLEITER-SATZ Part set of light guide	13733001	005
5	ISOLATOREN-SCHALTER -SATZ Part set - insulators, switch	14733001	015
6	FENSTER -SATZ Window set	15733001	013
7	TRAVERSE FÜR SCHERENSTROMABNEHMER Traverse for double arm pantograph	00177375	006
8	PRESSLUFTSCHALTER Compressed air switch	00187326	006
9	ZUGHAKEN-BREMSKUPPLUNG-SATZ Coupling hook-brake coupling-set	19733001	012
10	SCHILDER-SET ohne Abb. Plates set no ill.	19737802	013
11	PFEIFE Whistle	00197603	003
12	ZUGHEIZKABEL Heating cable	19793200	019
13	TRITT -SATZ Set of steps	19793400	005
14	GRIFSTANGEN-SATZ Set of handrails	19793100	008
15	WISCHER -SATZ Wiper set	19793300	013
16	PUFFERBOHLE KPL. Buffer beam cpl.	75733001	011
17	LOKFAHRGESTELL OHNE MOTOR Loco chassis w/o motor	40733001	018
18	MOTOR Motor	00507346	028
19	KOHLENHALTER Carbon holder	00507801	001
20	MOTORPLATINE KPL. INCL. LICHTPLATINE Motor PCB with light PCB	65719000	020
21	SCHNITTSTELLE BLINDSTECKER 6pol Interface connector guide 6pol	66401600	013
22	STECKPUFFER (GEWÖLBT) Plug in buffer (curved)	00757011	002
23	STECKPUFFER (FLACH) Plug in buffer (flat)	00757012	002
24	SCHNECKE D=4mm L=8mm Worm D=4mm L=8mm	00567604	006
25	ERSATZ-SCHLEIFKOHLEN Carbon brushes set	6518	---
26	KONTAKTBLECH -SATZ Contact sheet - set	61780300	007
27	SCHERENSTROMABNEHMER N Double arm pantograph N	67706300	020
28	SCHRAUBE M1,7x2,5 Screw M1,7x2,5	70900035	002
Sound			
29	MOTORPLATINE KPL. INCL. LICHTPLATINE Motor PCB with light PCB	65719200	020
30	LAUTSPRECHERAUFNAHME Speaker recording	68701800	016
31	SOUNDDECODER Sound decoder	68733071	041
32	LAUTSPRECHER 9x16 FOX MIT KLEBEPAD Loudspeaker 9x16	68701100	016

Änderungen in Konstruktion und Ausführung vorbehalten
We reserve the right to change the construction and specification

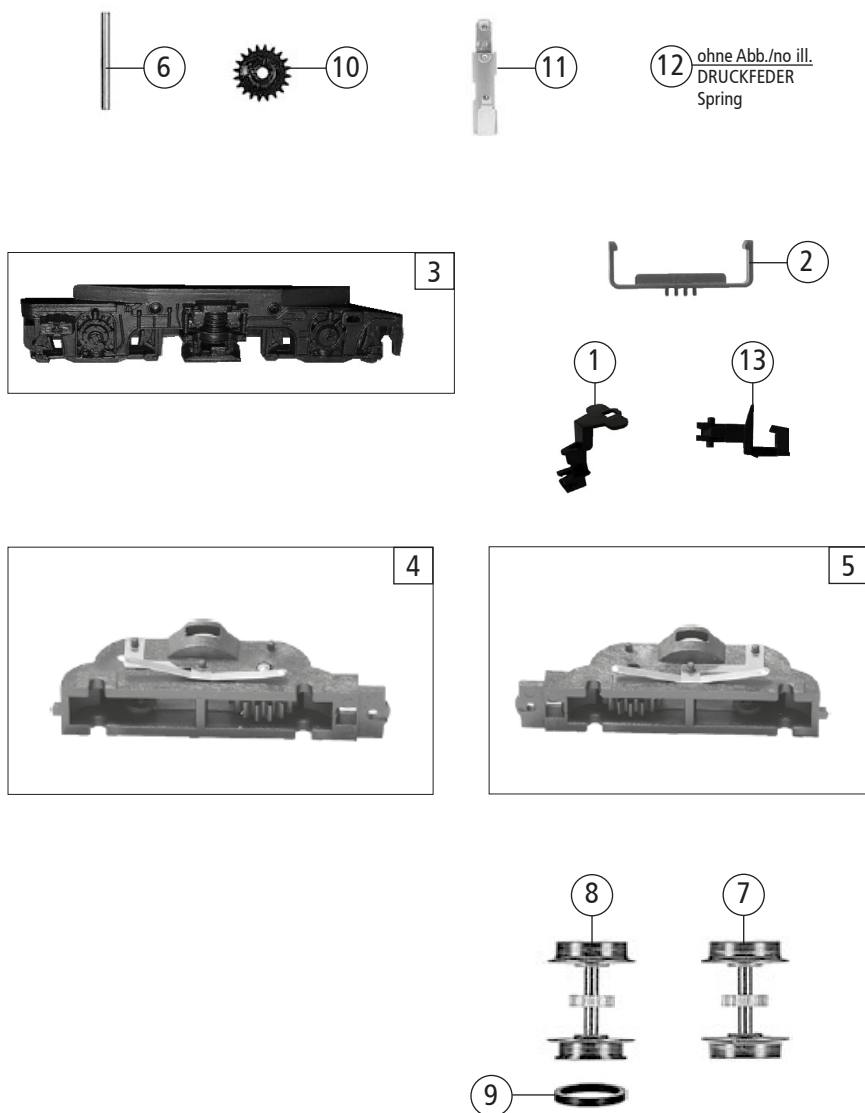

Pos. Nr. Pos.no.	Beschreibung Description	Art.-Nr. Art.no.	Preisgruppe Price bracket
733001	DB BR 140	=	N
733071		=	🔊
1	KUKU-DEICHSEL KUKU-drawbar	38702700	007
2	HALTEBÜGEL FÜR KUPPLUNG Holding plate for coupling	38902000	007
3	DREHGESTELLRAHMEN Bogie framework	41733001	011
4	DREHGESTELLBLOCK KPL. VORNE Bogie block cpl. front	45733001	017
5	DREHGESTELLBLOCK KPL. HINTEN Bogie block cpl. rear	46733001	017
6	ACHSE Z. DG-BEFESTIGUNG Axle for bogie fastening	00527002	002
7	RADSATZ M.Z.O.N. ROT Wheelset cpl. with gear wheel, w/o tract.tyre	00537018	012
8	RADSATZ M.Z.M.1 NUT BR 103/110/11 Wheelset complete with gear wheel, 1 tr.tyre	00537037	013
9	HAFTREIFEN Traction tyre	00547002	001
10	ZAHNRAD Z:20 SCHWARZ Gear wheel Z:20 black	00567101	003
11	KONTAKTBÜGEL F. DREHGEST. LOKS Contact strap	00657004	013
12	DRUCKFEDER ohne Abb. Spring no ill.	00767012	001
13	STANDARD-STECKKUPPLUNG Standard plug-in coupling	9525	---

Ersatzteile erhalten Sie direkt unter www.fleischmann.de, bei Ihrem Fachhändler, oder Ihrer Landesvertretung.
Spare parts can be ordered directly at www.fleischmann.de and from your local dealer or country representative.